

SURGICAL INSTRUMENTS

High *Quality* Products
Collection 2015

CATALOGUE **2015-2016**

WWW.USMIENT.COM



Buck

UE-1-101-18

Percussion Hammer
18.5 cm,



Buck

UE-1-102-18

Percussion Hammer
20cm,



Dejerine

UE-1-103-20

Percussion Hammer
20cm,



Dejerine

UE-1-104-21

Percussion Hammer
21cm,



Taylor Mod. USA

UE-1-105-20

Percussion Hammer
20cm,



Wartenberg

UE-1-106-19

Pinwheel
18cm,



Pinard
UE-1-107-18
Stethoscope
18 cm,



Pinard
UE-1-108-15
Stethoscope
15cm,



Magill

UE-2-101-15

Catheter Introducing Forceps
14.5 cm, 20 cm, 25 cm,



Miller

UE-2-102-00

Laryngoscope Sets



Miller-Baby

UE-2-103-00

Laryngoscope Sets



Miller

UE-2-104-00

Laryngoscope Blade
Fig. 0, Fig. 1, Fig. 2, Fig. 3, Fig. 4,



Guedel-Negus

UE-2-105-00

Laryngoscope Sets
Fig. 2, Fig. 3, Fig. 4,



Guedel-Negus

UE-2-106-00

Laryngoscope Sets
Fig. 1, Fig. 2, Fig. 3, Fig. 4,



Guedel-Negus
UE-2-107-01

Laryngoscope Blades
Fig. 1, Fig. 2, Fig. 3, Fig. 4,



McIntosh
UE-2-108-00



McIntosh
UE-2-109-00

Laryngoscope Blades
Fig. 0, Fig. 1, Fig. 2, Fig. 3, Fig. 4,



McIntosh
UE-2-110-00

Laryngoscope Sets
Fig. 1, Fig. 2, Fig. 3, Fig. 4,



Foregger
UE-2-111-01

Laryngoscope Blades
Fig. 1, Fig. 2, Fig. 3, Fig. 4,



Battery Handle
UE-2-112-00

Battery Handle



McIntosh

UE-2-114-00

Laryngoscope Sets fiber optic
Fig. 1, Fig. 2, Fig. 3,



McIntosh

UE-2-115-00

Laryngoscope Sets fiber optic
Fig. 1, Fig. 2, Fig. 3,



McIntosh

UE-2-116-00

Laryngoscope Sets fiber optic
Fig. 1, Fig. 2, Fig. 3,



McIntosh

UE-2-113-00

Laryngoscope Sets
Fig. 1, Fig. 2, Fig. 3, Fig. 4,



Universal
UE-3-101-04
Trocar
14 cm,



Nelson
UE-3-102-07
Trocar
20 cm,



Lichtwitz
UE-3-103-19
Antrum Trocar
18.5 cm,



Adson
UE-3-104-21
Suction Cannula
20 cm,



Frazier
UE-3-105-10
Suction Cannula
24 cm,



Frazier
UE-3-106-06
Suction Cannula
19.5 cm,



Poppen

UE-3-107-06

Suction Cannula
18 cm,



Luer

UE-3-108-30

Suction Tube working length 110 mm



Yasargil

UE-3-109-15

Suction Tube working length 150 mm with
Luer hub
21.5 cm,



Yankauer

UE-3-110-27

Suction Tube complete with suction tip and
connector
31 cm,



Yankauer

UE-3-111-00

Suction Tube
31 cm, 15 cm, 2.5 cm, 10 cm,



Poole

UE-3-112-22

Suction Tube
22 cm,



Poole
UE-3-113-22
Suction Tube
22.5 cm,



Nuboer
UE-3-114-21
Suction Tube
21 cm,



Nuboer
UE-3-115-21
Suction Tube
21 cm,



Quinke
UE-3-116-10
Lumbar Puncture Needle



Tuohy
UE-3-117-12
Lumbar Puncture Needle Luer Lock
connection with special tip



Verres
UE-3-118-20
Insufflation Cannula Luer Lock connection
15 cm,



Verres

UE-3-119-20

Insufflation Cannula Luer Lock connection
17 cm,



Kalt
UE-4-105-14
Needle Holder
13.5 cm,



Barraquer-Troutman
UE-4-106-10
Micro Needle Holder
10 cm, 10.5 cm,



Arruga
UE-4-107-14
Micro Needle Holder
13.5 cm,



Barraquer-Troutman
UE-4-108-10
Micro Needle Holder
10.5 cm, 11.5 cm,



Barraquer
UE-4-109-11
Micro Needle Holder
11.5 cm, 13.5 cm, 14 cm,



Barraquer
UE-4-110-13
Micro Needle Holder
13.5 cm,



Castroviejo-Fino
UE-4-111-01
Micro Needle Holder
13 cm,



Castroviejo-Fino
UE-4-112-01
Micro Needle Holder
13 cm,



Castroviejo-Fino
UE-4-113-01
very delicate jaw with lock
13 cm,



Castroviejo
UE-4-114-14
Micro Needle Holder with lock
14 cm,



Castroviejo
UE-4-115-14
Micro Needle Holder
14 cm,



Castroviejo
UE-4-121-14
Micro Needle Holder with lock
14 cm,



Castroviejo
UE-4-122-14

Micro Needle Holder
14 cm,



Castroviejo
UE-4-124-13

Micro Needle Holder with lock
12 cm,



Arruga
UE-4-123-16

Needle Holder delicate
16 cm,



Castroviejo
UE-4-125-12

Micro Needle Holder with lock
12 cm,



Derf

UE-4-126-12
Needle Holder
12 cm, 13 cm,

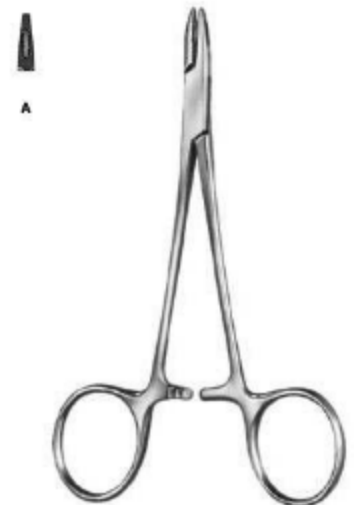

Collier

UE-4-127-12
Needle Holder
12.5 cm,



Webster
UE-4-128-13
Needle Holder
13 cm,



Halsey
UE-4-129-13
Needle Holder
13.5 cm,



Neivert
UE-4-130-13
Needle Holder
12.5 cm,



Hegar-Baumgartner
UE-4-131-14
Needle Holder
14.5 cm,



Crile-Murray
UE-4-133-15
Needle Holder
15 cm,



Crile-Wood
UE-4-134-15
Needle Holder
15 cm,



Adson

UE-4-140-18

Needle Holder one fenestrated jaw
18 cm,



Metzenbaum

UE-4-141-18

Needle Holder one grooved and fenestrated
jaw
18.5 cm,



M. G. Hospital

UE-4-142-17

Needle Holder
17.5 cm,



Mayo-Hegar

UE-4-143-14

Needle Holder
14.5 cm, 16 cm, 18.5 cm, 20.5 cm, 24 cm, 26.5
cm,



Mayo-Hegar

UE-4-144-16

Needle Holder
16 cm, 18.5 cm, 20.5 cm,



Brown

UE-4-145-13

Needle Holder
13 cm, 18 cm,

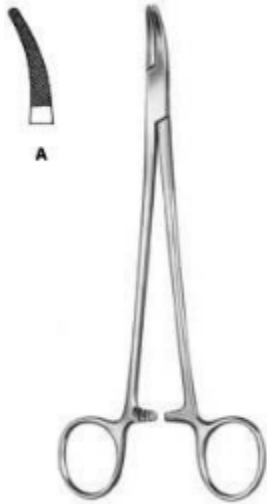

Heaney
UE-4-146-21
Needle Holder
20.5 cm,

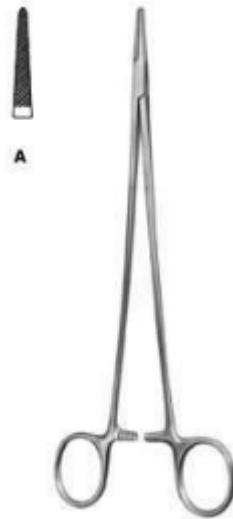

Jamison
UE-4-147-23
Needle Holder
23.5 cm,



Masson
UE-4-148-27
Needle Holder
26.5 cm,



Finochietto
UE-4-149-27
Needle Holder
26.5 cm,



Wangenstein
UE-4-150-27
Needle Holder
26.5 cm,

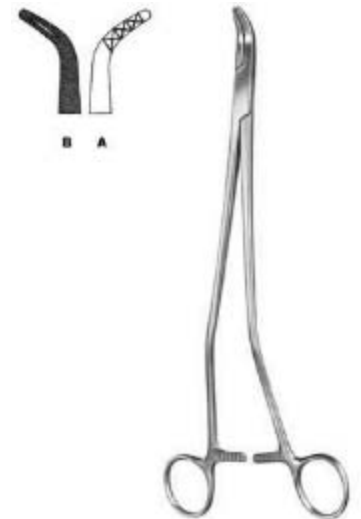

Johnson
UE-4-151-27
Needle Holder
27 cm,

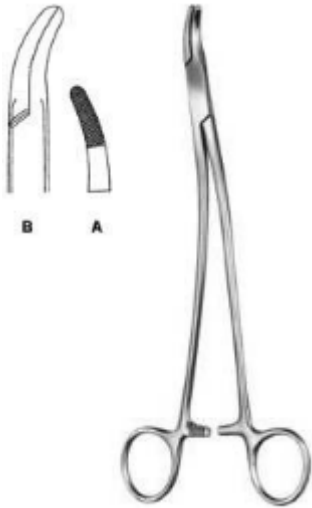

Stratte
UE-4-152-23
Needle Holder
23 cm,



Olsen-Hegar
UE-4-153-14
Needle Holder
14 cm,

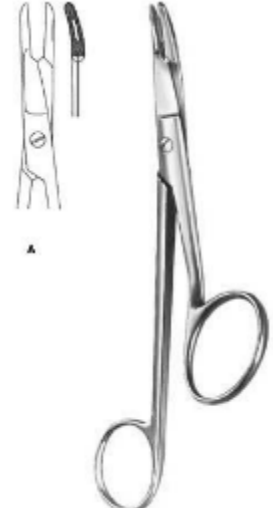

Gillies
UE-4-154-16
Needle Holder
16 cm,



Crile
UE-4-155-15
Needle Holder
15 cm,



Mathieu
UE-4-156-14
Needle Holder
14 cm, 17 cm, 20 cm,



Mathieu
UE-4-157-14
Needle Holder
14 cm, 16.5 cm,



Toennis
UE-4-158-18
Needle Holder
18.5 cm,



Lichtenberg
UE-4-159-20
Needle Holder
20 cm,



UE-4-160-16
Micro Needle Holder
16 cm,



UE-4-161
Micro Needle Holder
23 cm, 19 cm,



Hepp-Scheidel
UE-4-162-18
Micro Needle Holder smooth jaw
18 cm,

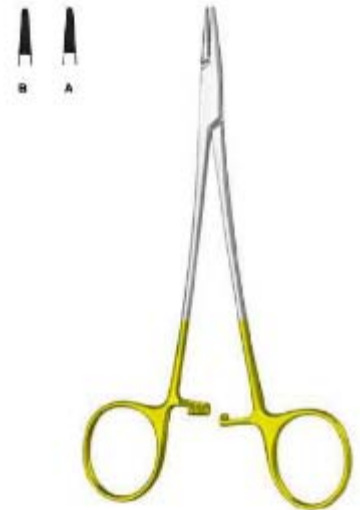

Webster
UE-4-163-13
Needle Holder with automatic release ratchet
also for lefthanders
13 cm, 15 cm,



UE-4-164-15

Micro Needle Holder
15 cm, 18 cm, 21 cm, 23 cm,



JABOMA

UE-4-165-18
Micro Needle Holder
18 cm,



Castroviejo

UE-4-166
Micro Needle Holder
14.5 cm, 18 cm, 21.5 cm,



Arruga

UE-4-167
Needle Holder
16 cm,



Castroviejo

UE-4-168-13
Micro Needle Holder
12.5 cm,



Barraquer

UE-4-169-13
Micro Needle Holder
13 cm,



Barraquer
UE-4-170-13

Micro Needle Holder
13 cm,



Webster
UE-4-171-13

Needle Holder
13 cm,



Derf
UE-4-173-12

Needle Holder
12 cm,

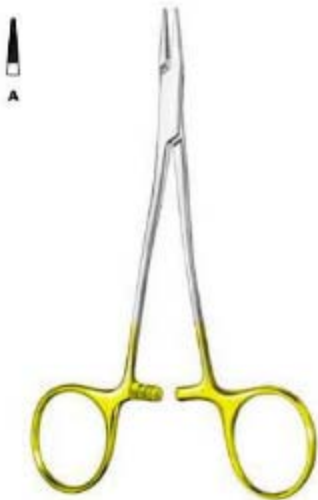

Kilner

UE-4-172-13

Needle Holder
13 cm,



Hegar-Baumgartner

UE-4-174-13

Needle Holder
13 cm, 14.5 cm,



Halsey

UE-4-175-12

Needle Holder
13 cm, 12 cm,



Crile-Wood
UE-4-176-15
Needle Holder
15 cm,



Sarot
UE-4-177-18
Needle Holder
18 cm, 20 cm, 26 cm,



Mayo-Hegar
UE-4-178-16
Needle Holder standard profile
16 cm, 18 cm, 20 cm, 24 cm, 26 cm, 30 cm,



Heaney
UE-4-179-20
Needle Holder
20 cm, 24 cm, 26 cm,



DeBakey
UE-4-180-18
Needle Holder delicate pattern mini profile
18 cm, 20 cm, 23 cm, 26 cm, 31 cm,



Masson
UE-4-181-27
Needle Holder
26.5 cm,



Ryder (Martin)

UE-4-182-13

Needle Holder

12.5 cm, 15 cm, 18 cm, 20 cm, 23 cm, 26 cm,



Martin

UE-4-183-15

Needle Holder mini profile elastic type

15 cm, 17 cm, 20 cm,



Wangensteen

UE-4-184-27

Needle Holder standard profile

27 cm,



Hegar-Vascular

UE-4-185-14

Needle Holder micro profile

14 cm, 18.5 cm, 20.5 cm, 23 cm,



Bozemann

UE-4-186-20

Needle Holder standard profile

20.5 cm, 24 cm, 26.5 cm, 29 cm,



Hegar

UE-4-187-20

Needle Holder standard profile

20 cm, 23.5 cm,



Stratte

UE-4-188-22

Needle Holder standard profile
23 cm,



Microvascular

UE-4-189-00

Needle Holder slender pattern micro profile
14 cm, 17.5 cm, 20 cm, 23 cm,



Mathieu

UE-4-190-14

Needle Holder
14 cm, 17 cm, 20 cm,



Mathieu

UE-4-191-14

Needle Holder
14 cm, 17 cm, 20 cm,



Mathieu

UE-4-192-17

Needle Holder standard profile with interior
ratchet
17 cm, 20 cm, 23 cm,



Toennis

UE-4-193-18

Needle Holder
18.5 cm,



Lichtenberg
UE-4-194-20

Needle Holder lightweight model standard profile
20 cm,



Langenbeck
UE-4-195-18
Needle Holder
18 cm, 20.5 cm, 23 cm,



Zweifel
UE-4-196-20
Needle Holder with hinged ratchet standard profile
20.5 cm, 23 cm,



Reverdin
UE-4-197-15

Reverdin Needle short
14.5 cm Fig. 1, 14.5 cm Fig. 2, 14.5 cm Fig. 3, 14.5 cm Fig. 4,



Reverdin
UE-4-198-19
Reverdin Needle medium
19.5 cm Fig. 1, 19.5 cm Fig. 2, 19.5 cm Fig. 3, 19.5 cm Fig. 4,



Reverdin
UE-4-199-23
Reverdin Needle long
23 cm Fig. 1, 23 cm Fig. 2, 23 cm Fig. 3, 23 cm Fig. 4,



Schmieden-Dick

UE-4-201-01

Ligature Needle malleable
29 cm,

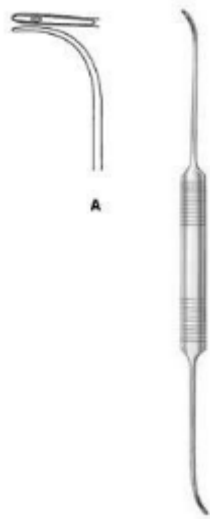

Schmieden

UE-4-202-21

Ligature Needle
24 cm,



UE-4-203-20

Ligature Needle malleable
20.5 cm,

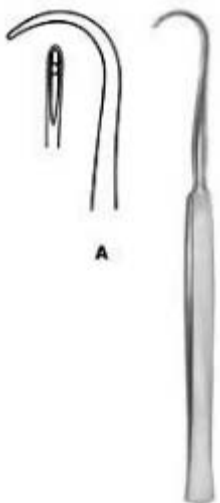

Cooper

UE-4-204-19

Ligature Needle
18.5 cm,



Kronecker

UE-4-205-13

Ligature Needle delicate for right hand
12.5 cm,

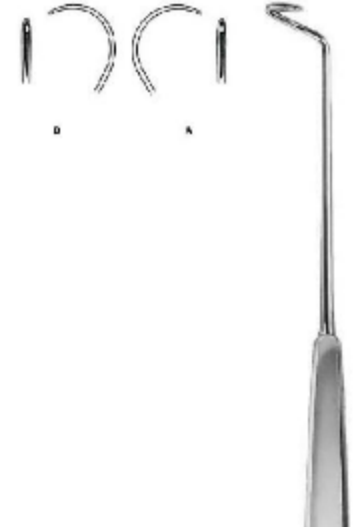

Deschamps

UE-4-206-24

Ligature Needle blunt for right hand
24 cm,



Deschamps
UE-4-207-20

Ligature Needle blunt for right hand
20 cm,



Deschamps
UE-4-208-20

Ligature Needle sharp for right hand
20 cm,

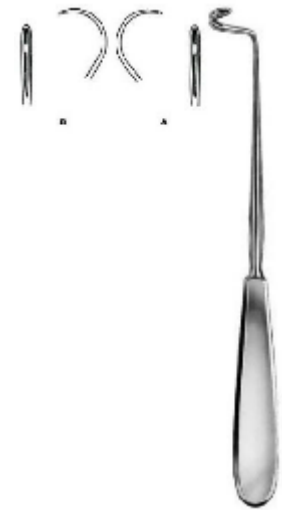

Deschamps
UE-4-209-21

Ligature Needle blunt for right hand
20 cm,

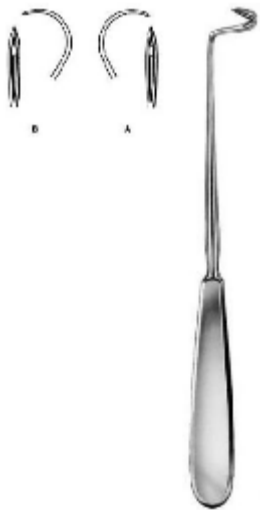

Deschamps
UE-4-210-21

Ligature Needle sharp for right hand
20 cm,

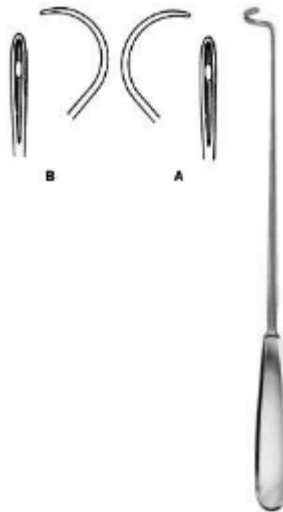

Deschamps
UE-4-211-27

Ligature Needle blunt for right hand
27 cm,

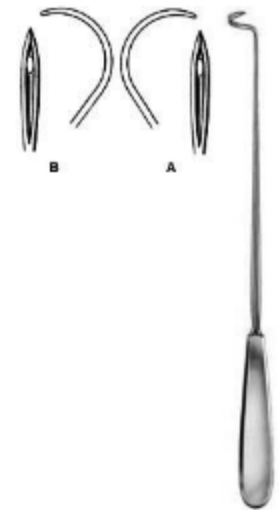

Deschamps
UE-4-212-27

Ligature Needle sharp for right hand
27 cm,

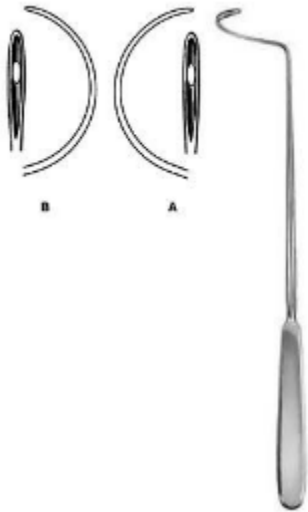

Deschamps
UE-4-213-28

Ligature Needle blunt for right hand
28 cm,



Deschamps
UE-4-214-20

Ligature Needle sharp for right hand
20 cm,



Deschamps
UE-4-215-20

Ligature Needle blunt for right hand
20 cm,



Deschamps
UE-4-216-20

Ligature Needle blunt for right hand
21 cm,

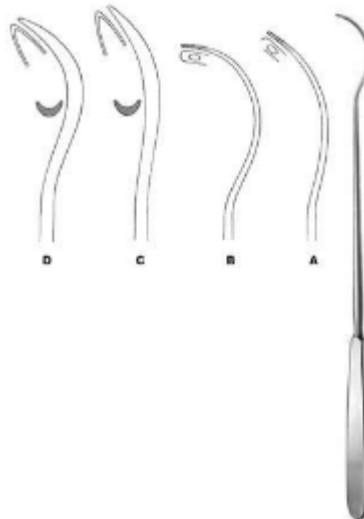

Brunner
UE-4-217-30

Ligature Needle
21 cm,



Kirschner
UE-4-218-25

Ligature Conductor
25.5 cm,



UE-4-219-28
Ligature Conductor
28 cm,



Modell Wien
UE-4-220-23
Ligature Catcher
23.5 cm,



Michel
UE-4-221-12
Clip Applying Forceps
12 cm,



Hegenbarth
UE-4-222-12
Clip Applying Forceps
12 cm,

Scalpels



UE-5-101-01

Dissecting Knife with metal handle
15 cm, 15.5 cm, 16 cm, 17 cm,



UE-5-102-10

Autopsy Knife
25.5 cm,



Walb

UE-5-104-17

Post Mortem Knife



Virchow

UE-5-105-20

Brain Knife with hollow handle
28.5 cm, 33.5 cm, 38 cm,



UE-5-108-04

Scalpel Handle solid
13.5 cm,



UE-5-109-34

Scalpel Handle
16 cm,

Scalpels



UE-5-110-41

Scalpel Handle solid, long
21 cm,



UE-5-111-45

Scalpel Handle
21 cm,



Collin

UE-5-112-08

Scalpel Handle with hollow handle
13.5 cm,



Collin

UE-5-113-09

Scalpel Handle with hollow handle
14.5 cm,



UE-5-114-03

Scalpel Handle solid
12 cm,



UE-5-115-04

Scalpel Handle
12 cm,

Scalpels



UE-5-116-05
Scalpel Handle
12 cm,



UE-5-117-31
Scalpel Handle solid, long
21.5 cm,



UE-5-118-35
Scalpel Handle
21 cm,



UE-5-119-07
Scalpel Handle solid
16 cm,



UE-5-120-71
Scalpel Handle solid short
12.5 cm,



UE-5-121-03
Scalpel Handle with round hollow handle
15.5 cm,



UE-5-127-16

Amputation Knife with hollow handle
29 cm,



UE-5-128-19

Amputation Knife with hollow handle
32.5 cm,



Catlin

UE-5-129-16

Interosseous Knife with hollow handle
29cm,



UE-5-130-06

Resection Knife solid handle, dissecting end
18 cm,



Langenbeck

UE-5-131-05

Resection Knife
18 cm,



Langenbeck

UE-5-132-05

Resection Knife
18 cm,

Scalpels



UE-5-133-00

Razor Knife hollow blades on both sides
cutting length 75mm



Schink

UE-5-134-00

Dermatome complete with 2 skin fixing plates
and one blade
31 cm,



Schink

UE-5-135-01

Spare Blade spare blade for KE-05-134-00



Schink

UE-5-136-02

Skin Fixing Plate for KE-05-134-00

Scissors



Standard BL / BL Straight

UE-5-201-13

Operating Scissor Special Price: \$1.25

12 cm, 13 cm, 14.5 cm, 16.5 cm, 18.5 cm, 20.5 cm,



Standard SH / BL STR

UE-5-202-13

Operating Scissors

12 cm, 13 cm, 14.5 cm, 16.5 cm, 18.5 cm, 20.5 cm,



Standard SH / SH STR

UE-5-204-13

Operating Scissors

12 cm, 13 cm, 14.5 cm, 16.5 cm,



Standard BL / BL Curved

UE-5-205-13

Operating Scissors

12 cm, 13 cm, 14.5 cm, 16.5 cm, 18.5 cm, 20.5 cm,



Standard SH / BL Curved

UE-5-206-13

Operating Scissors

12 cm, 13 cm, 14.5 cm, 16.5 cm, 18.5 cm, 20.5 cm,



Standard SH / SH Curved

UE-5-207-13

Operating Scissors

12 cm, 13 cm, 14.5 cm, 16.5 cm,



Standard BL / BL Curved
UE-5-208-14
Operating Scissors delicate
14.5 cm,



Incision Scissor
UE-5-209-14
Operating Scissor
14.5 cm,



Deaver
UE-5-210-14
Operating Scissors



Mayo
UE-5-211-15
Dissecting Scissors
14.5 cm, 15 cm, 17 cm, 23.5 cm, 14.5 cm, 15 cm, 17 cm, 23.5 cm,



Mayo
UE-5-212-23
Dissecting Scissors
23 cm, 22.5 cm, 28 cm,



Mayo-Harrington
UE-5-213-22
Dissecting Scissors
23 cm, 22.5 cm, 28 cm,

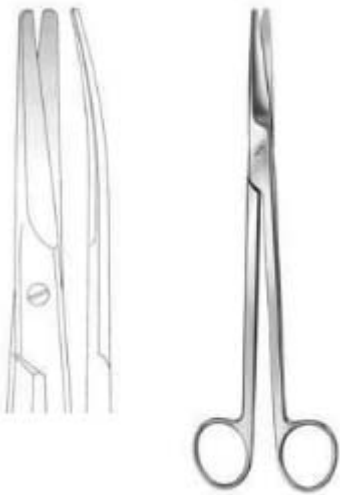

Mayo-Harrington

UE-5-214-22

Dissecting Scissors cur.
22.5 cm, 28 cm, 23 cm,

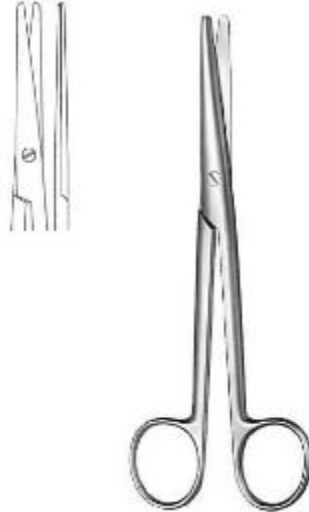

Mayo-Stille

UE-5-215-17

Dissecting Scissors str.
15 cm, 17 cm,

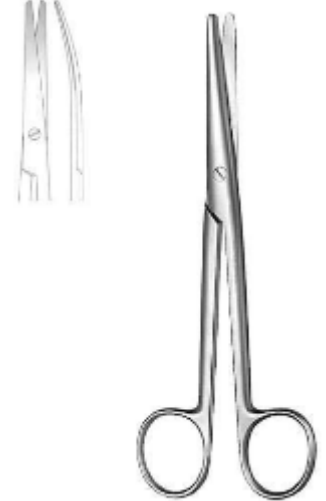

Mayo-Stille

UE-5-216-15

Dissecting Scissors cur.
15 cm, 17 cm,

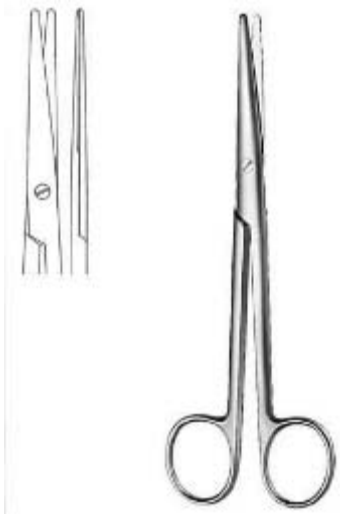

Mayo-Stille

UE-5-217-19

Dissecting Scissors str.
16 cm, 19.5 cm, 21.5 cm,

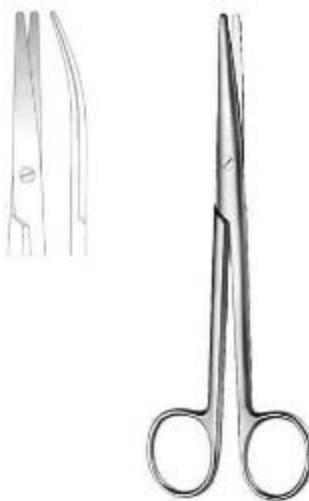

Mayo-Stille

UE-5-218-16

Dissecting Scissors cur.
16 cm, 19.5 cm, 21.5 cm,



Mayo-Noble

UE-5-219-17

Gynecological Scissors
16.5 cm,



Sims

UE-5-220-23

Gynecological Scissors str.
20 cm, 23 cm,



Sims

UE-5-221-20

Gynecological Scissors cur.
20 cm, 23 cm,



Kelly

UE-5-222-16

Operating Scissors
16 cm,



Doyen

UE-5-223-17

Gynecological Scissors
18.5 cm,



Sims-Siebold

UE-5-224-24

Gynecological Scissors
24.5 cm,



Sims-Siebold

UE-5-225-24

Gynecological Scissors
24.5 cm,



Wertheim

UE-5-226-23

Gynecological Scissors
20 cm, 23 cm,



Metzenbaum

UE-5-227-11

Dissecting Scissors
11.5 cm,



Metzenbaum

UE-5-228-14

Dissecting Scissors
14.5 cm,



Metzenbaum

UE-5-229-15

Dissecting Scissors
15.5 cm,



Metzenbaum-Nelson

UE-5-230-20

Dissecting Scissors
18 cm, 20.5 cm, 23 cm, 26 cm, 28.5 cm, 31 cm,



Metzenbaum-Nelson

UE-5-231-20

Dissecting Scissors
18 cm, 20.5 cm,



Metzenbaum-Nelson

UE-5-232-20

Dissecting Scissors

18 cm, 20.5 cm, 23 cm, 26 cm, 28.5 cm, 31 cm,



Metzenbaum

UE-5-233-14

Dissecting Scissors toothed

14.5 cm,



Nerve Operating Scissor

UE-5-234-15

Dissecting Scissors

15.5 cm,



Gorney

UE-5-235-19

Face-lift Scissors str.

12.5 cm, 19.5 cm,



Gorney

UE-5-236-19

Face-lift Scissors cur.

19.5 cm,



Aston

UE-5-237-17

Face-lift Scissors

17 cm,



Lexer

UE-5-238-16

Dissecting Scissors
16 cm,



Cinelli

UE-5-239-14

Nasal Scissors
11.5 cm, 14 cm,



Thorek

UE-5-240-19

Dissecting Scissors
18.5 cm,



Lexer-Baby

UE-5-241-10

Dissecting Scissors
10 cm,



Lexer-Fino

UE-5-242-16

Delicate Dissecting Scissors slender pattern
16.5 cm,



Metzenbaum-Fino

UE-5-243-14

Delicate Dissecting Scissors slender pattern
14.5 cm,



Metzenbaum-Fino
UE-5-244-14
Delicate Dissecting Scissors
14.5 cm,



Metzenbaum-Fino
UE-5-245-14
Delicate Dissecting Scissors
14.5 cm,



Metzenbaum-Fino
UE-5-246-14
Delicate Dissecting Scissors
14.5 cm,

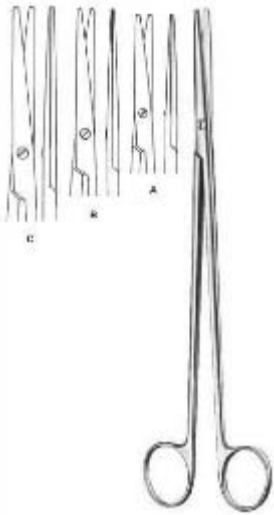

Metzenbaum-Fino
UE-5-247-18
Delicate Dissecting Scissors slender pattern
18 cm, 20 cm, 23 cm,

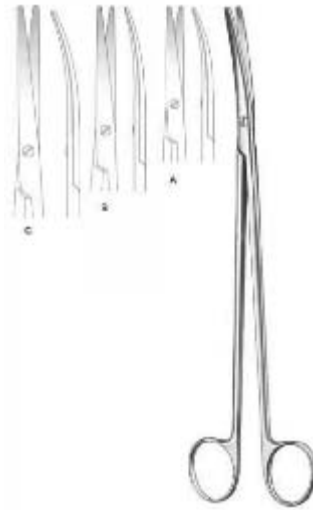

Metzenbaum-Fino
UE-5-248-18
Delicate Dissecting Scissors slender pattern
18 cm, 20 cm, 23 cm,

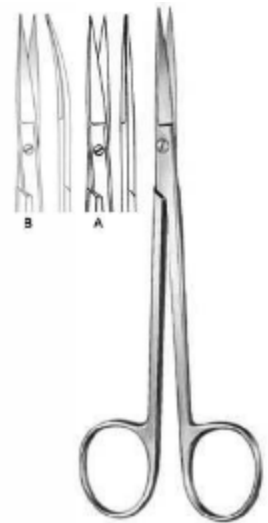

Sanvenero
UE-5-250-14
Operating Scissors
14 cm,

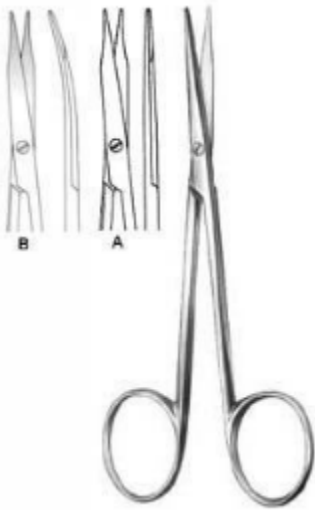

UE-5-251-11

Fine Operating Scissors
11.5 cm,

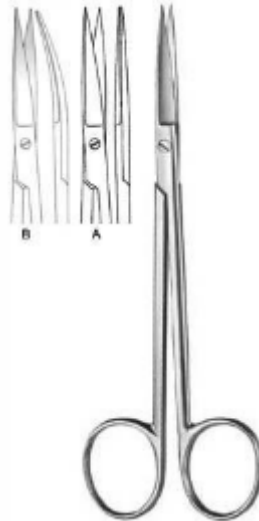

Joseph

UE-5-252-14

Operating Scissors
14.5 cm,

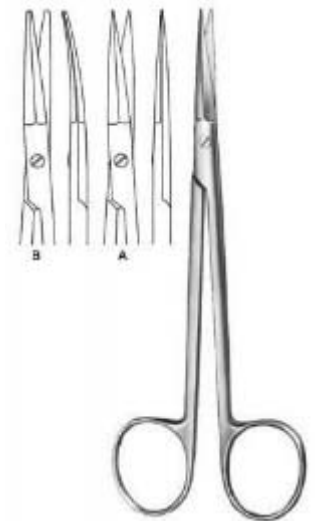

Peck-Joseph

UE-5-253-14

Face-lift Scissors
14.5 cm,

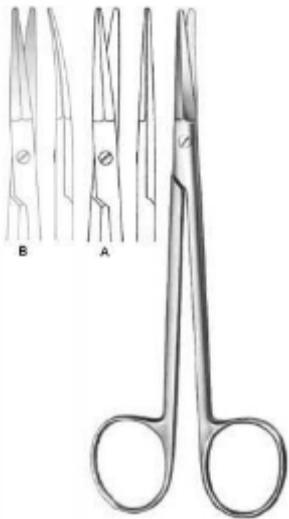

Peck-Joseph

UE-5-254-14

Face-lift Scissors
14.5 cm,



Shea Vein Graft

UE-5-255-12

Dissecting Scissors
12 cm,

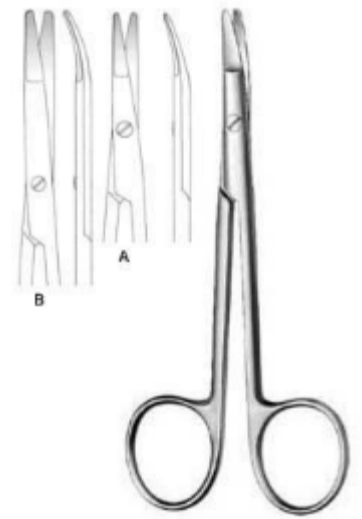

Kilner

UE-5-256-12

Dissecting Scissors
12 cm, 15 cm,

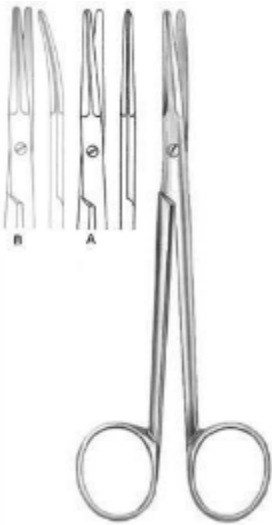

UE-5-257-14

Dissecting Scissors
14.5 cm,

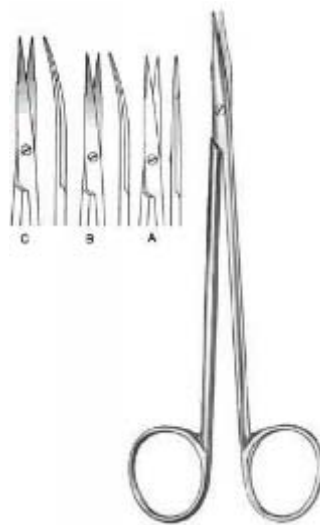

Reynolds

UE-5-258-15

Dissecting Scissors
15.5 cm, 18 cm,



Jameson

UE-5-259-14

Dissecting Scissors
15.5 cm,



Jameson

UE-5-260-14

Dissecting Scissors
15.5 cm,



UE-5-261-19

Vascular Scissors
19 cm,



UE-5-262-24

Vascular Scissors fine, short blades
19 cm, 25.5 cm,

Scissors

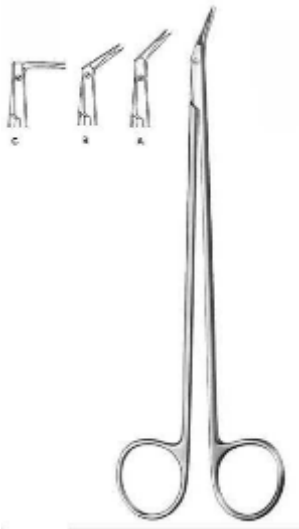

Diethrich

UE-5-263-25

Vascular Scissors
19 cm, 18.5 cm, 17.5 cm,

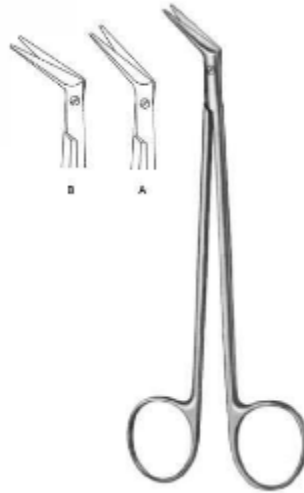

DeBakey

UE-5-264-45

Vascular Scissors
16.5 cm, 16 cm,



Potts-Smith

UE-5-265-19

Vascular Scissors
18 cm, 18.5 cm, 19 cm,



Coronary Scissors

UE-5-266-25

Cardiovascular Surgery Scissor
18 cm,



Coronary Scissors

UE-5-267-45

Cardiovascular Surgery Scissors
18 cm,



Coronary Scissors

UE-5-268-60

Cardiovascular Surgery Scissor
18 cm,



Coronary Scissors

UE-5-269-90

Cardiovascular Surgery Scissor
18 cm,



Coronary Scissors

UE-5-270-00

Cardiovascular Surgery Scissor
18 cm,



Coronary Scissors

UE-5-271-00

Cardiovascular Surgery Scissor
18 cm,



Coronary Scissors

UE-5-272-25

Cardiovascular Surgery Scissor
18 cm,



Coronary Scissors

UE-5-273-45

Cardiovascular Surgery Scissor
18 cm,



Coronary Scissors

UE-5-274-90

Cardiovascular Surgery Scissor
18 cm,



Schmieden-Taylor

UE-5-275-17

Dura Scissors
15 cm,



Strully

UE-5-276-22

Neurosurgical Scissors
22.5 cm,



Toennis-Adson

UE-5-277-17

Dissecting Scissors
17.5 cm,



Good

UE-5-279-19

Tonsil Scissors
19.5 cm,



Fomon

UE-5-282-15

Nasal Scissors
15 cm,



Cottle

UE-5-283-16

Nasal Scissors
16 cm,



Heymann
UE-5-284-18
Nasal Scissors
18.5 cm,



Heymann
UE-5-285-18
Nasal Scissors
18.5 cm,



Converse
UE-5-286-11
Nasal Scissors blunt & sharp
10.5 cm,



Waldmann
UE-5-287-18
Episiotomy Scissors
18 cm,



Braun-Stadler
UE-5-288-14
Episiotomy Scissors
14.5 cm,



Braun-Stadler
UE-5-289-22
Episiotomy Scissors
22 cm,



Modell USA

UE-5-290-10

Umbilical Scissors
10.5 cm,



Busch

UE-5-292-16

Umbilical Scissors
16 cm,



Goldmann-Fox

UE-5-293-13

Gum Scissors
13 cm,



Wagner

UE-5-294-12

Operating Scissors
12 cm,

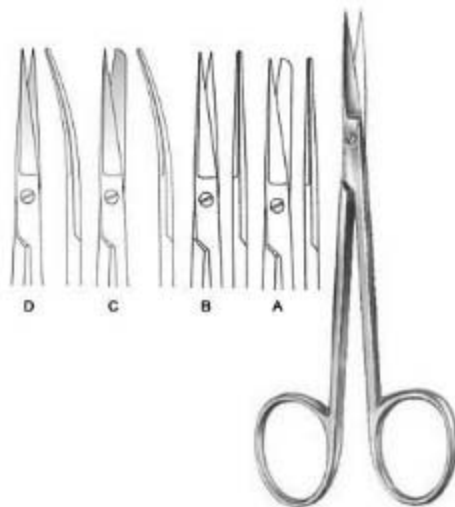

UE-5-295-12

Operating Scissors small model
12 cm,



La Grange

UE-5-296-11

Gum Scissors S-shaped
11.5 cm,



UE-5-297-11

Dissecting Scissors delicate
11.5 cm,



Locklin

UE-5-298-16

Gum Scissors
16 cm,



Locklin

UE-5-299-16

Gum Scissors
16 cm,



UE-5-300-08

Operating Scissors very delicate
9 cm,

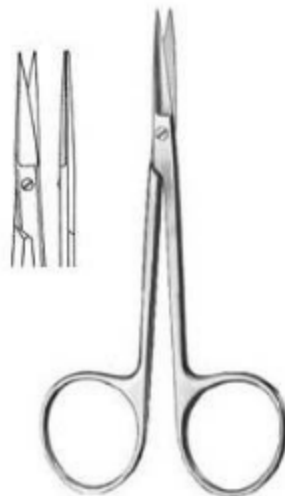

Locklin

UE-5-301-10

Iris Scissors
9 cm, 10 cm,

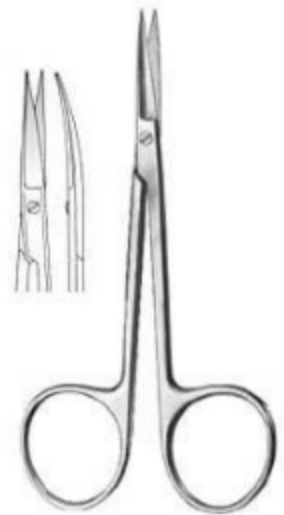

Locklin

UE-5-302-10

Iris Scissors extra flat blades
10 cm,



UE-5-303-10

Iris Scissors extra flat blades
10 cm,



Bonn

UE-5-304-09

Iris Scissors



Dean

UE-5-278-17

Tonsil Scissors
17.5 cm,



Spencer Scissor

UE-0-

Dressing & Tissue Forceps



Standard

UE-5-401-10

Dressing Forceps

10.5 cm, 11.5 cm, 13 cm, 14.5 cm, 16 cm, 18 cm, 20 cm, 23 cm, 25 cm, 30.5 cm,



Standard

UE-5-402-11

Dressing Forceps

12 cm, 13 cm, 14.5 cm, 16 cm, 18 cm, 20 cm, 25 cm, 30 cm,



UE-5-403-13

Dressing Forceps

13 cm, 14.5 cm,



Stille

UE-5-404-15

Dressing Forceps

15 cm,



Mini-Adson

UE-5-405-12

Dressing Forceps

12 cm,



Adson

UE-5-406-12

Dressing Forceps

12 cm, 15 cm,

Dressing & Tissue Forceps



McIndoe
UE-5-407-15
Dressing Forceps
15 cm,



Waugh
UE-5-408-20
Dressing Forceps
20 cm,



Semken
UE-5-409-12
Dressing Forceps
12.5 cm, 15 cm,



Taylor
UE-5-410-17
Dressing Forceps
12.5 cm, 15 cm,



Taylor
UE-5-411-17
Dressing Forceps
17 cm,



Taylor
UE-5-412-17
Dressing Forceps
18.5 cm,

Dressing & Tissue Forceps



UE-5-413-06

Micro Dressing Forceps
15.5 cm,



Gerald

UE-5-414-18

Dressing Forceps
15.5 cm,



Cushing

UE-5-415-17

Dressing Forceps
17.5 cm,



Potts-Smith

UE-5-416-18

Dressing Forceps
18 cm, 21 cm, 24.5 cm,



Bonney

UE-5-417-17

Dissecting Forceps
17.5 cm,



Gerald

UE-5-418-17

Dissecting Forceps
17.5 cm,

Dressing & Tissue Forceps



Gillies

UE-5-419-15

Dissecting Forceps
15.5 cm,



McIndoe

UE-5-420-15

Dressing Forceps
15 cm,



Semken

UE-5-421-16

Dissecting Forceps
15.5 cm, 17.5 cm,



Adson-Brown

UE-5-422-12

Dissecting Forceps
12 cm,



Adson

UE-5-423-12

Dissecting Forceps
12 cm, 15 cm,



Adson

UE-5-424-12

Dressing Forceps
12 cm, 15 cm,

Dressing & Tissue Forceps



Cushing
UE-5-425-17
Dressing Forceps
17.5 cm,



Cushing
UE-5-426-18
Dressing Forceps
17 cm,



Cushing-Taylor
UE-5-427-18
Dressing Forceps
18.5 cm,



Potts-Smith
UE-5-428-15
Dressing Forceps
16 cm, 18.5 cm, 20 cm, 23 cm, 25 cm,



Oehler
UE-5-429-14
Dissecting Forceps
14.5 cm, 16 cm, 18 cm, 20 cm, 25 cm,



Wangensteen
UE-5-430-15
Dressing Forceps
15 cm, 23 cm,

Dressing & Tissue Forceps



DeBakey

UE-5-431-15

Atraumatic Dressing Forceps

16 cm, 20 cm, 24.5 cm, 16 cm, 20 cm, 24.5 cm,



DeBakey

UE-5-432-16

Atraumatic Dressing Forceps

16 cm, 20 cm, 24 cm,



UE-5-433-10

Dissecting Forceps

10.5 cm, 11.5 cm, 13 cm, 14.5 cm, 16 cm, 18 cm, 20 cm, 23 cm, 25 cm, 30.5 cm,

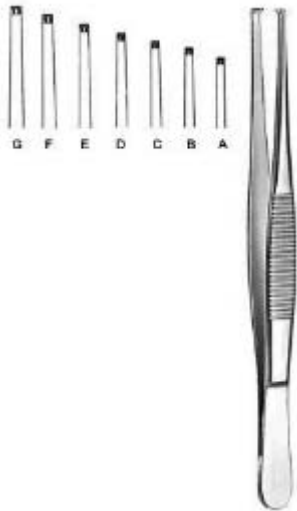

UE-5-434-11

Dissecting Forceps

12 cm, 13 cm, 14.5 cm, 15.5 cm, 18 cm, 20 cm, 24.5 cm,



UE-5-435-14

Dissecting Forceps

14.5 cm, 16 cm,



UE-5-436-14

Dissecting Forceps

14.5 cm, 16 cm,

Dressing & Tissue Forceps



UE-5-437-13

Dissecting Forceps
13 cm, 14.5 cm, 16 cm, 20 cm,



UE-5-438-13

Dissecting Forceps
13 cm, 14.5 cm,



Stille

UE-5-439-15
Dissecting Forceps
15 cm,



Stille

UE-5-440-15
Dissecting Forceps
15 cm,



Stone

UE-5-441-15
Dissecting Forceps
15 cm,



Lerche

UE-5-442-15
Dissecting Forceps
15 cm,

Dressing & Tissue Forceps



Adlerkreutz
UE-5-443-15

Dissecting Forceps
15.5 cm, 20.5 cm, 16 cm, 20 cm, 25 cm,

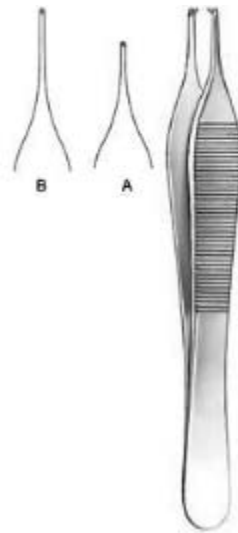

Adson
UE-5-444-12

Dissecting Forceps
12 cm, 15 cm,



Gillies

UE-5-445-15

Dissecting Forceps
15.5 cm,



Waugh

UE-5-446-20

Dissecting Forceps
20.5 cm,



Semken

UE-5-447-12

Dissecting Forceps
12.5 cm, 15 cm,



Taylor

UE-5-448-17

Dissecting Forceps
17.5 cm,

Dressing & Tissue Forceps



Taylor

UE-5-449-17

Dissecting Forceps
17 cm,



Taylor

UE-5-450-17

Dissecting Forceps
18.5 cm,



UE-5-451-06

Micro Dissecting Forceps
15.5 cm,



Gerald

UE-5-452-17

Dissecting Forceps
17.5 cm,



Cushing

UE-5-453-17

Dissecting Forceps
18 cm,



Potts-Smith

UE-5-454-18

Dissecting Forceps
18 cm, 21 cm, 24 cm,

Dressing & Tissue Forceps

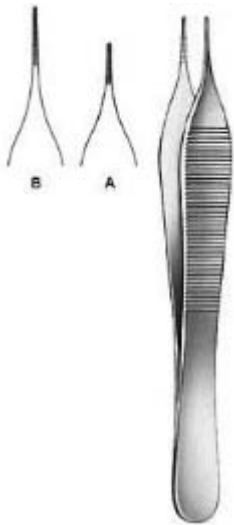

Mikro-Adson
UE-5-455-12
Dressing Forceps
12 cm, 15 cm,

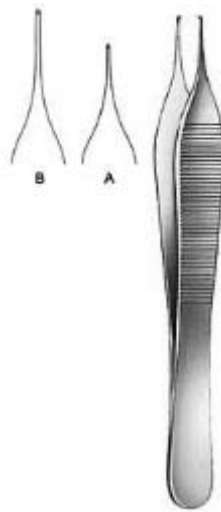

Mikro-Adson
UE-5-456-12
Dissecting Forceps
12 cm, 15 cm,



UE-5-457-11
Dissecting Forceps
10.5 cm,



Micro Jewelers
UE-5-458-12
Jeweler Type Forceps
12 cm Fig. 7,



Jewelers
UE-5-459-12
Jeweler Type Forceps
12 cm Fig. 3,



Jewelers
UE-5-460-11
Jeweler Type Forceps
11 cm Fig. 3c,

Dressing & Tissue Forceps



Jewelers

UE-5-461-11

Jeweler Type Forceps
11 cm Fig. 5,



Jewelers

UE-5-462-11

Jeweler Type Forceps
11 cm Fig. 4,



Stille-Barraya

UE-5-463-18

Dissecting Forceps
18 cm,



Bonney

UE-5-464-18

Dissecting Forceps
17.5 cm,



Nelson

UE-5-465-23

Dissecting Forceps
23 cm,



UE-5-466-10

Dressing Forceps
10 cm, 9.5 cm,

Dressing & Tissue Forceps



UE-5-467-12
Splinter Forceps smooth jaw
12.5 cm,



UE-5-468-12
Splinter Forceps smooth jaw
12.5 cm,



UE-5-469-12
Splinter Forceps
12.5 cm,



UE-5-470-12
Splinter Forceps
12.5 cm,



UE-5-471-16
Micro Tying Forceps
15.5 cm,



UE-5-472-10
Microscopic Forceps super light, blunt
10 cm,

Dressing & Tissue Forceps



UE-5-473-10
Microscopic Forceps
10 cm,



Shaaf
UE-5-474-09
Splinter Forceps
9.5 cm,



Littauer
UE-5-475-08
Cilia Forceps
8.5 cm,



UE-5-476-09
Cilia Forceps
8.5 cm,



Douglas
UE-5-477-09
Cilia Forceps
9 cm,



Douglas
UE-5-478-09
Cilia Forceps
9 cm,



Beer

UE-5-479-09

Cilia Forceps
9 cm,

Splinter Forceps



Phaneuf

UE-5-501-21

Hysterectomy Forceps
20.5 cm,



Wertheim-Cullen

UE-5-502-21

Vaginal Clamp
21 cm,

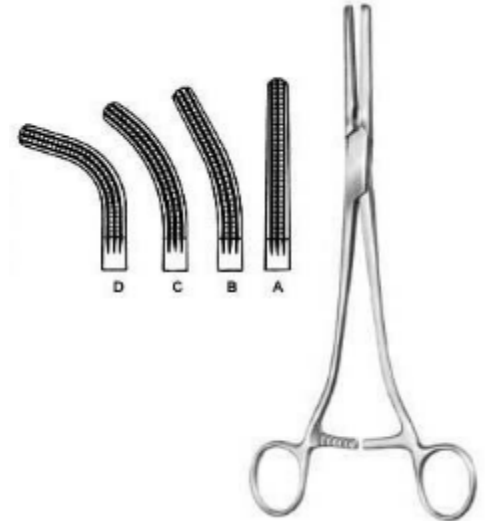

Rogers

UE-5-503-10

Hysterectomy Forceps
21.5 cm Fig. 1, 21 cm Fig. 2, 20.5 cm Fig. 3, 20 cm Fig. 4,



Moynihan

UE-5-504-23

Hysterectomy Forceps
23 cm,



Moynihan

UE-5-505-24

Hysterectomy Forceps
23.5 cm,



Wertheim

UE-5-506-25

Hysterectomy Forceps
26 cm,

Splinter Forceps

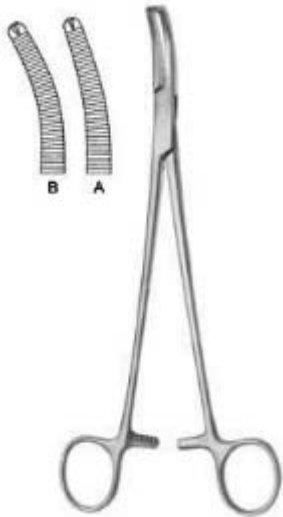

Wertheim

UE-5-507-22

Hysterectomy Forceps
22.5 cm,



Mikulicz, Baby

UE-5-508-14

Peritoneum Forceps
14.5 cm,



Mikulicz

UE-5-509-18

Peritoneum Forceps
20.5 cm,



Mikulicz

UE-5-510-20

Peritoneum Forceps
18.5 cm,



Mikulicz

UE-5-511-20

Peritoneum Forceps
20 cm,



Mikulicz

UE-5-512-21

Peritoneum Forceps
20.5 cm,



Faure

UE-5-513-20

Peritoneum Forceps
21 cm,

Haemostatic Forceps

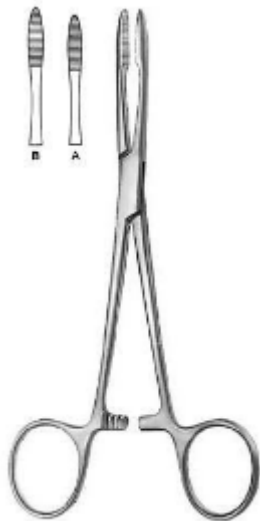

Pean

UE-5-601-14

Haemostatic Forceps
14.5 cm, 16 cm,

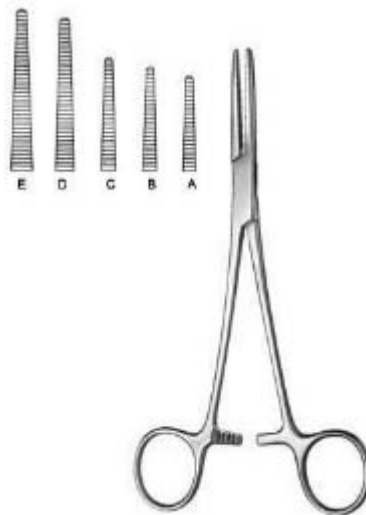

Spencer-Wells

UE-5-602-13

Haemostatic Forceps
13 cm, 14 cm, 15.5 cm, 18.5 cm, 20 cm,

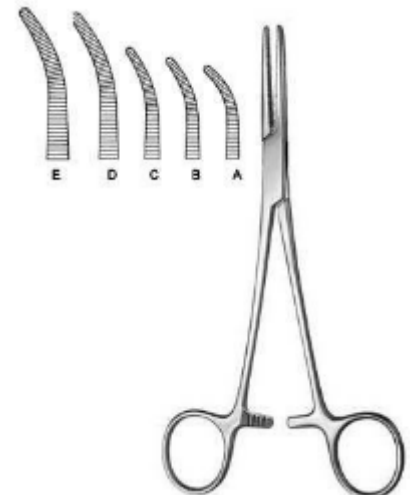

Spencer-Wells

UE-5-603-13

Haemostatic Forceps
13 cm, 14 cm, 15 cm, 18 cm, 20 cm,



Chaput

UE-5-604-13

Haemostatic Forceps
12.5 cm,



Tuffier

UE-5-605-13

Haemostatic Forceps
12.5 cm,

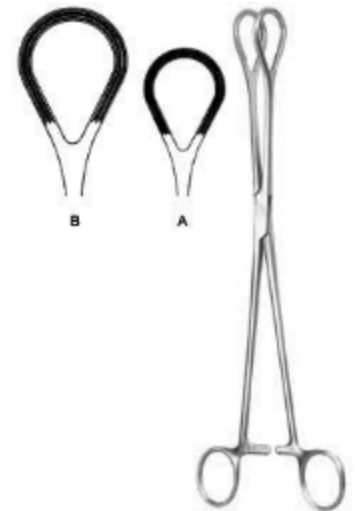

UE-5-606-25

Organ Grasping Forceps

Haemostatic Forceps



Collin

UE-5-607-14

Organ Grasping Forceps
15.5 cm, 21 cm,



Collin

UE-5-608-17

Tumor Grasping Forceps
17 cm,



Pennington

UE-5-609-15

Haemostatic Forceps
15.5 cm,



Pratt

UE-5-610-15

Haemostatic Forceps
15 cm,



Martel-Rees

UE-5-611-14

Face-lift Forceps
13.5 cm,



UE-5-612-12

Ligature Forceps

Haemostatic Forceps



Mixer-Baby

UE-5-613-01

Dissecting and Ligature Forceps
13.5 cm, 13 cm,

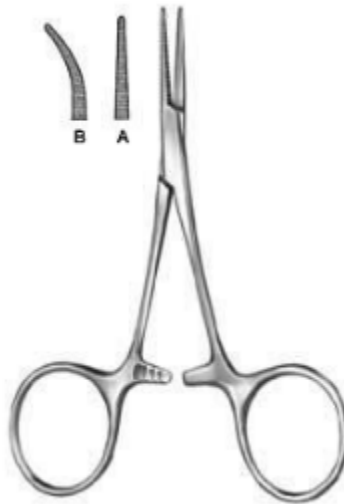

Hartmann

UE-5-614-10

Haemostatic Forceps
10 cm, 9.5 cm,



UE-5-615-12

Ligature Forceps

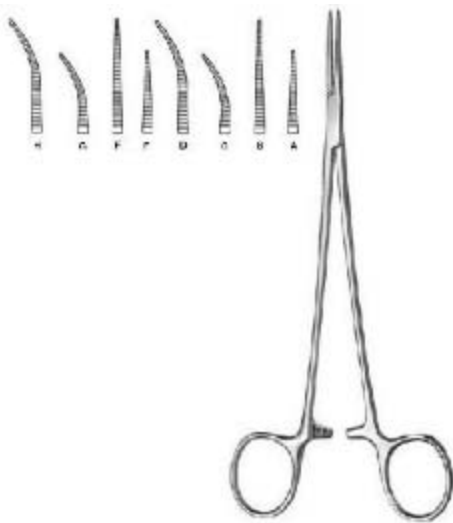

Halsted-Mosquito

UE-5-616-18

Haemostatic Forceps
12.5 cm, 14.5 cm, 14 cm,



Mikro-Mosquito

UE-5-617-10

Haemostatic Forceps
10 cm, 12 cm, 9.5 cm, 11.5 cm,



Providence-Hospital

UE-5-618-14

Haemostatic Forceps
14 cm,

Haemostatic Forceps



Leriche

UE-5-619-15

Haemostatic Forceps
15.5 cm, 15 cm,

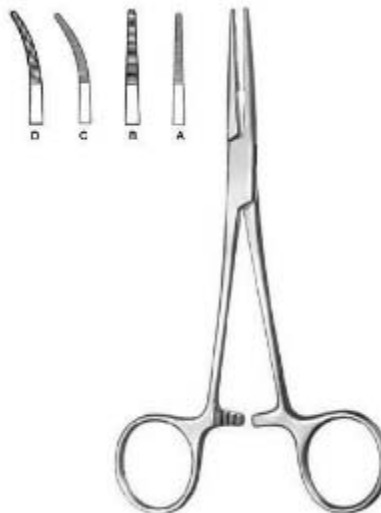

Kelly

UE-5-620-14

Haemostatic Forceps
14.5 cm, 14 cm,



Kelly-Rankin

UE-5-621-16

Haemostatic Forceps
16 cm, 15.5 cm,



Overholt-Baby

UE-5-622-14

Dissecting and Ligature Forceps
14.5 cm, 14 cm,



Crile

UE-5-623-14

Haemostatic Forceps
14.5 cm, 14 cm,



Crile-Rankin

UE-5-624-16

Haemostatic Forceps
16.5 cm, 16 cm,

Haemostatic Forceps



Lovelace

UE-5-625-15

Haemostatic Forceps
16 cm,



Dandy-Mosquito

UE-5-626-12

Haemostatic Forceps
12 cm,

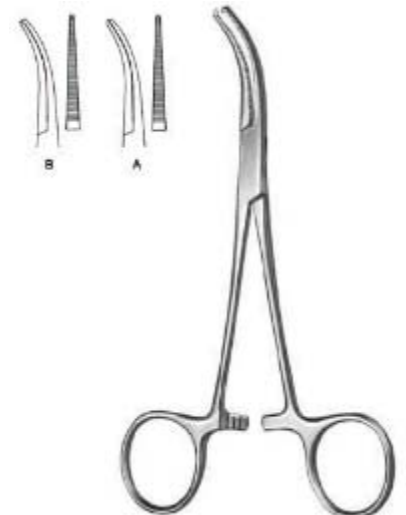

Dandy

UE-5-627-14

Haemostatic Forceps
14.5 cm, 14 cm,



Schnidt

UE-5-628-18

Dissecting and Ligature Forceps
18.5 cm, 19 cm,



Adson

UE-5-629-18

Dissecting and Ligature Forceps
19 cm, 18.5 cm,



Martin-Fuchsig

UE-5-630-20

Dissecting and Ligature Forceps
20.5 cm,

Haemostatic Forceps

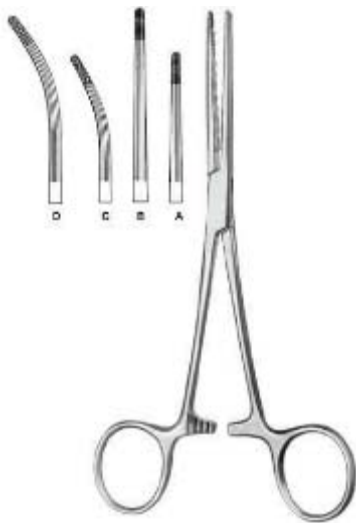

Rochester-Carmalt

UE-5-631-16

Haemostatic Forceps
17 cm, 20.5 cm, 16.5 cm, 20 cm,

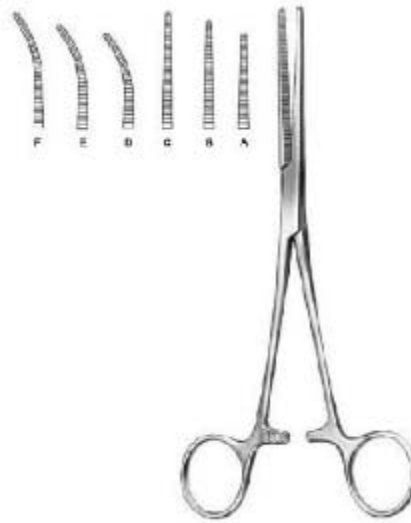

Pean

UE-5-632-13

Haemostatic Forceps
13.5 cm, 14.5 cm, 17 cm, 13 cm, 14 cm, 16.5 cm,

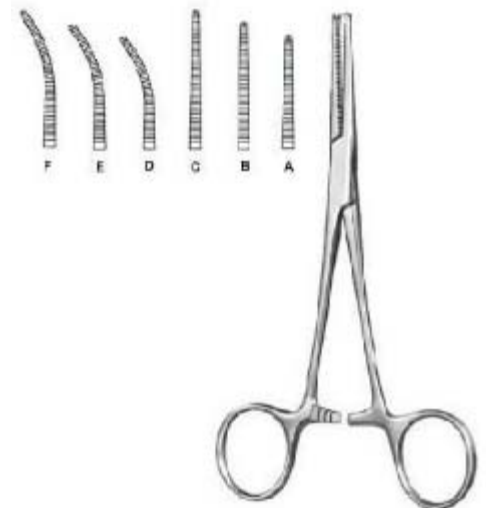

Kocher-Nippon

UE-5-633-14

Haemostatic Forceps
14.5 cm, 16.5 cm, 18.5 cm, 16 cm, 18 cm,

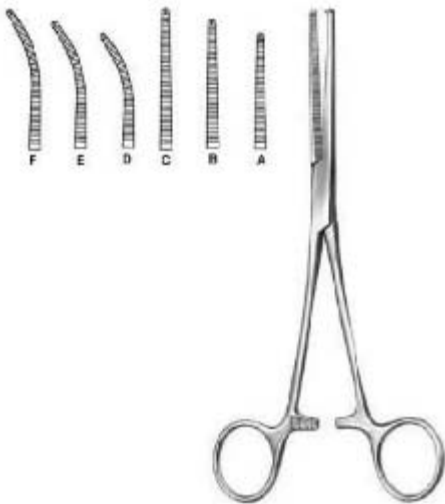

Kocher

UE-5-635-13

Haemostatic Forceps
13 cm, 14 cm, 16 cm,

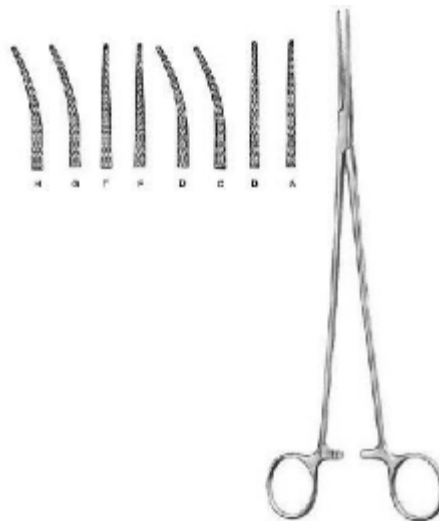

Bengolea

UE-5-636-20

Haemostatic Forceps
21.5 cm, 26 cm, 21 cm, 21.5 cm,

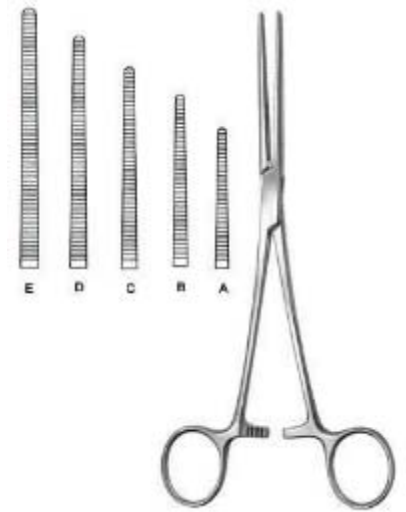

Pean (Rochester)

UE-5-637-14

Haemostatic Forceps
14.5 cm, 16.5 cm, 18.5 cm, 20.5 cm, 22.5 cm, 24.5 cm, 26 cm, 30.5 cm, 14 cm, 16 cm,

Haemostatic Forceps

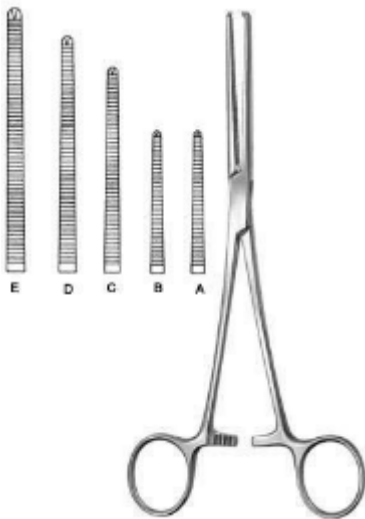

Kocher (Ochsner)

UE-5-638-14

Haemostatic Forceps

14.5 cm, 16.5 cm, 18.5 cm, 20.5 cm, 22.5 cm, 24.5 cm, 26 cm, 30.5 cm,

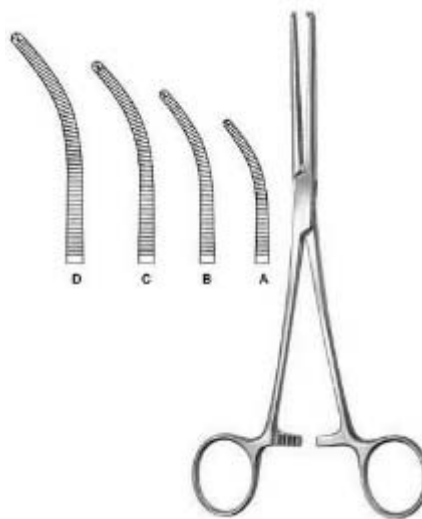

Kocher (Ochsner)

UE-5-639-14

Haemostatic Forceps

14 cm, 16 cm, 18 cm, 20 cm, 22 cm, 24 cm, 25.5 cm, 30 cm,

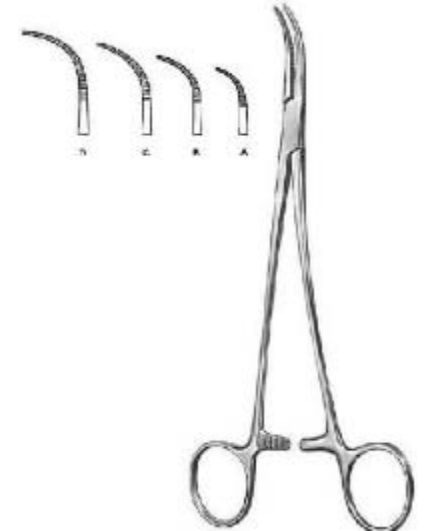

Overholt-Martin

UE-5-640-01

Dissecting and Ligature Forceps

18.5 cm Fig. 1, 20.5 cm Fig. 2, 21 cm Fig. 3, 21.5 cm Fig. 4, 24.5 cm Fig. 5,



Mixer-Baby

UE-5-641-18

Dissecting and Ligature Forceps

18.5 cm,



Adson-Baby

UE-5-642-14

Dissecting and Ligature Forceps

14.5 cm, 18 cm,



Heiss

UE-5-643-20

Dissecting and Ligature Forceps

21 cm, 20.5 cm, 20 cm,

Haemostatic Forceps



Overholt-Mixter

UE-5-644-21

Dissecting and Ligature Forceps
21.5 cm,

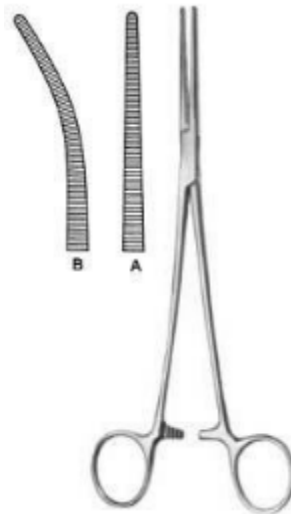

Roberts

UE-5-645-22

Dissecting and Ligature Forceps
22.5 cm, 21.5 cm,

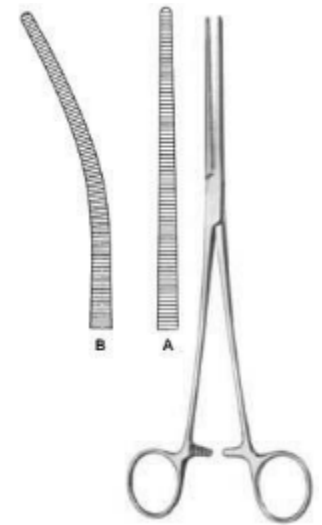

Sarot

UE-5-646-24

Dissecting and Ligature Forceps
25 cm, 24.5 cm,

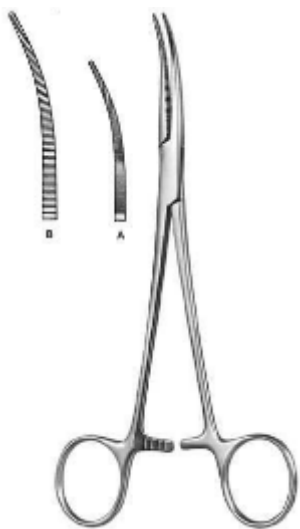

Crafoord

UE-5-647-18

Dissecting and Ligature Forceps
18 cm, 24.5 cm,

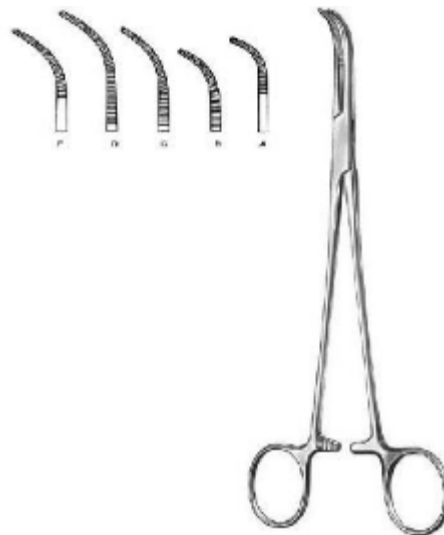

Overholt-Geissendorfer

UE-5-648-01

Dissecting and Ligature Forceps
20.5 cm Fig. 1, 20 cm Fig. 2, 21.5 cm Fig. 3, 22 cm Fig. 4, 21.5 cm Fig. 5, 22 cm Fig. 6, 27 cm Fig. 1, 26.5 cm Fig. 2, 27.5 cm Fig. 3, 28 cm Fig. 4,

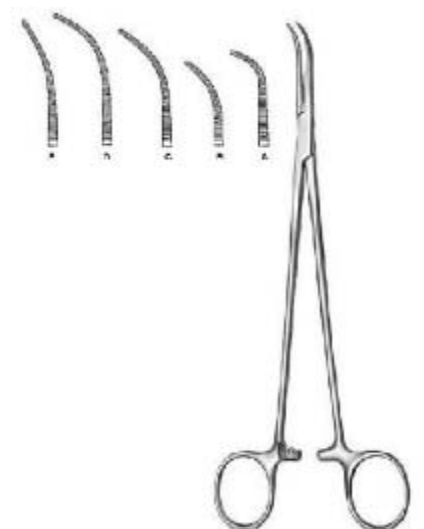

Overholt-Fino

UE-5-649-00

Dissecting and Ligature Forceps
21.5 cm, 21 cm, 22 cm, 23 cm, 22.5 cm,

Haemostatic Forceps

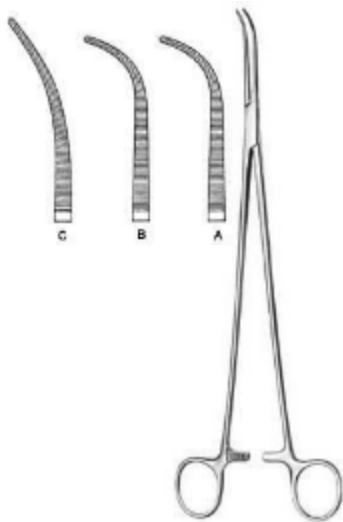

Overholt

UE-5-650-00

Dissecting and Ligature Forceps
29.5 cm, 30 cm,



Overholt-Mini

UE-5-651-01

Dissecting and Ligature Forceps
15 cm, 20 cm,



Gemini

UE-5-652-13

Dissecting and Ligature Forceps
13 cm, 16 cm, 18 cm, 21 cm, 23 cm, 25 cm, 28 cm,

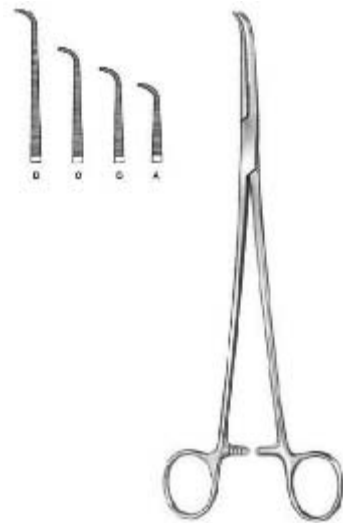

Mini-Gemini

UE-5-653-18

Dissecting and Ligature Forceps
18 cm, 22.5 cm, 25 cm, 28.5 cm,

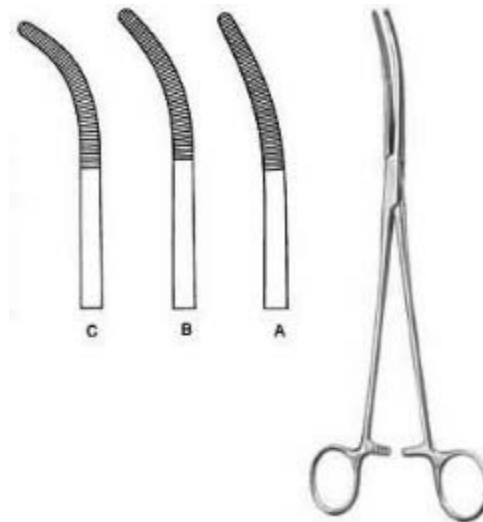

Rumel

UE-5-654-01

Dissecting and Ligature Forceps
24 cm Fig. 1, 23.5 cm Fig. 2, 23 cm Fig. 3, 24 cm Fig. 4, 23.5 cm Fig. 5,



Zenker

UE-5-655-01

Dissecting and Ligature Forceps
29.5 cm, 28.5 cm,

Haemostatic Forceps



Mixer-Baby
UE-5-656-14

Dissecting and Ligature Forceps
13.5 cm,

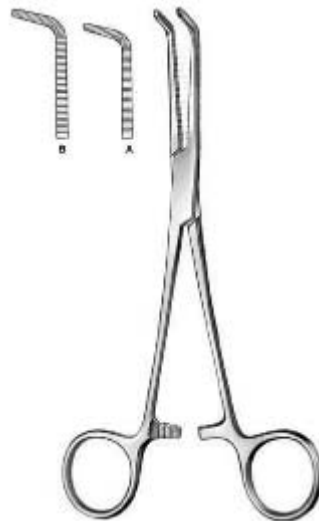

Mixer

UE-5-657-15

Dissecting and Ligature Forceps
16 cm, 18 cm,



Mixer-O Shaugnessy

UE-5-658-19

Dissecting and Ligature Forceps
18 cm,



Mixer

UE-5-659-22

Dissecting and Ligature Forceps
22.5 cm,



Mixer

UE-5-660-23

Dissecting and Ligature Forceps
23 cm,



Wickstrom

UE-5-661-21

Dissecting and Ligature Forceps
21 cm, 24.5 cm,

Haemostatic Forceps



Mixer

UE-5-662-22

Dissecting and Ligature Forceps
22.5 cm, 26 cm, 28 cm,



Mc Quigg-Mixer

UE-5-663-22

Dissecting and Ligature Forceps
23.5 cm,



Lower

UE-5-664-18

Dissecting and Ligature Forceps
18.5 cm,



Lahey

UE-5-665-19

Bile Duct Clamp
19.5 cm, 22.5 cm,



Finochietto

UE-5-666-24

Dissecting and Ligature Forceps
24 cm,



Uro-Tangential

UE-5-667-01

Tangential Forceps
25 cm, 27 cm,

Haemostatic Forceps

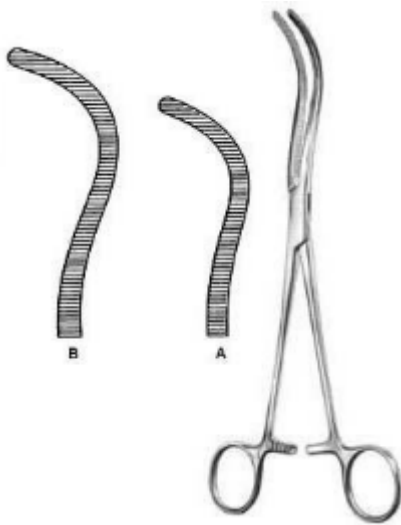

Guyon

UE-5-668-20

Kidney Pedicle Clamp
23 cm, 24 cm,



Guyon

UE-5-669-23

Kidney Pedicle Clamp
19.5 cm, 21.5 cm, 24 cm,



Desjardins

UE-5-670-21

Bile Duct Clamp
21 cm,



Kelly

UE-5-671-19

Dissecting and Ligature Forceps
19.5 cm Fig. 1, 22.5 cm Fig. 1, 24.5 cm Fig.
1, 19 cm Fig. 2, 22 cm Fig. 2, 24 cm Fig.
2, 18.5 cm Fig. 3, 21.5 cm Fig. 3, 23.5 cm Fig.
3,



Lawrence

UE-5-672-28

Dissecting and Ligature Forceps
28 cm,



Meeker

UE-5-673-28

Dissecting and Ligature Forceps
28 cm,



Negus

UE-5-674-19

Haemostatic Forceps
19.5 cm Fig. 1, 20 cm Fig. 2,

Towel & Tubing Clamps



Schaedel

UE-5-701-09

Towel Clamp sharp
9 cm,



Jones

UE-5-702-05

Towel Clamp sharp
5.5 cm, 8.5 cm,



Jones-Martin

UE-5-703-09

Towel Clamp sharp
8.5 cm,



Backhaus

UE-5-704-11

Towel Clamp
11.5 cm, 13 cm,



Backhaus

UE-5-705-11

Towel Clamp
11.5 cm,



Backhaus

UE-5-706-08

Towel Clamp
9 cm, 11.5 cm, 13 cm, 16 cm,

Towel & Tubing Clamps



Peers-Bertram modif.

UE-5-707-15

Towel Clamp wide jaw for tube fixation
15.5 cm,



R?der

UE-5-708-13

Towel Clamp
13.5 cm,

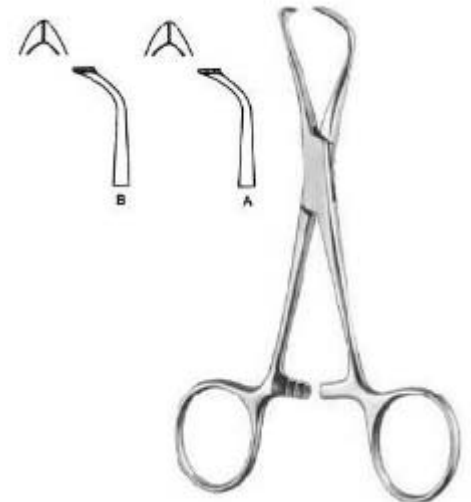

Lorna

UE-5-709-10

Towel Clamp fine serrated, wide jaw
9.5 cm, 13 cm,



Bernhard

UE-5-710-16

Towel Clamp
16.5 cm,

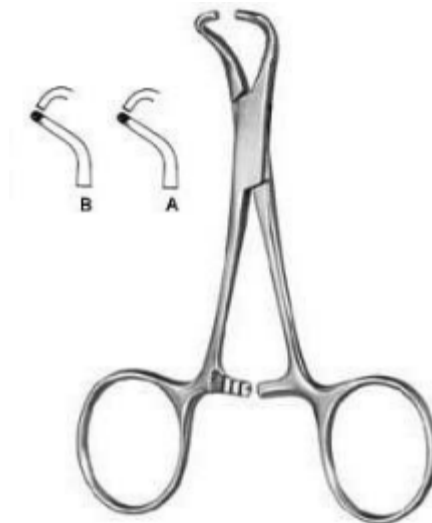

Tohoku

UE-5-711-10

Towel Clamp
10.5 cm blunt, 13.5 cm blunt, 14.5 cm,

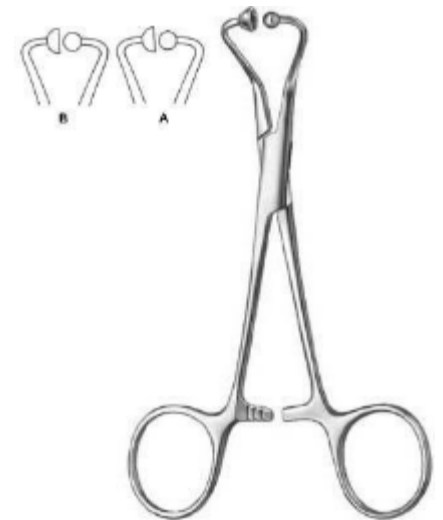

UE-5-712-11

Towel Clamp for paper clothes
11.5 cm, 14 cm,

Towel & Tubing Clamps



Lane

UE-5-713-20

Towel Clamp
19.5 cm,



UE-5-714-06

Tube Holder for fixation of six tubes



UE-5-715-14

Tubing Clamp extra long ratchet
14 cm,



UE-5-716-16

Tubing Clamp
16.5 cm,

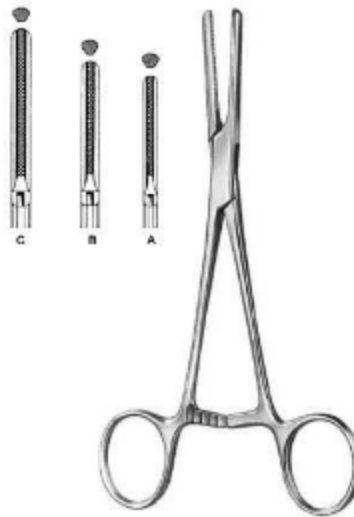

UE-5-717-15

Tubing Clamp
15.5 cm, 19 cm, 20.5 cm,

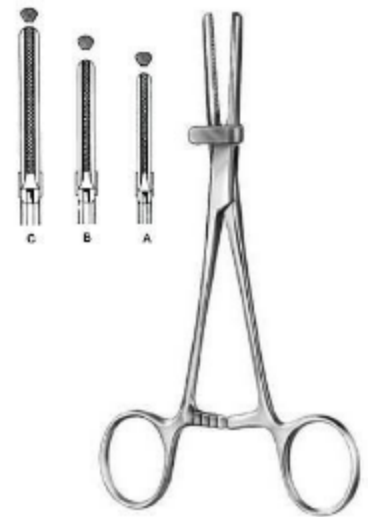

UE-5-718-15

Tubing Clamp with safety guard
15.5 cm, 19 cm, 20.5 cm,

Dressing & Sponge Forceps

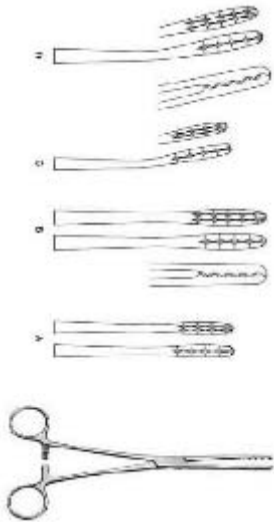

Ulrich

UE-5-801-22

Dressing Forceps
22.5 cm, 26.5 cm,



Lister

UE-5-802-13

Sinus Forceps
13 cm, 16 cm, 18 cm,



Martin

UE-5-803-17

Dressing Forceps
17.5 cm, 17 cm,

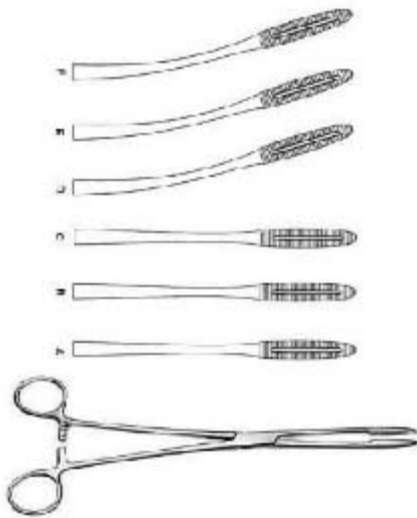

Gross-Maier

UE-5-804-20

Dressing Forceps
20.5 cm, 22 cm, 26.5 cm, 20 cm, 21.5 cm, 26 cm,



UE-5-805-40

Tunneling Forceps
39.5 cm,



Collin

UE-5-806-25

Dressing Forceps
25.5 cm,

Dressing & Sponge Forceps



Cheron
UE-5-807-25
Dressing Forceps
23.5 cm,



Bozemann
UE-5-808-26
Sponge Forceps
26 cm,



Foerster
UE-5-809-25
Sponge Forceps
25 cm, 18 cm, 20.5 cm, 24.5 cm, 17.5 cm, 20 cm, 24.5 cm,

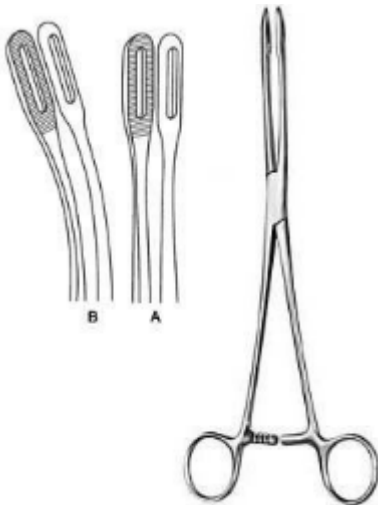

Foerster
UE-5-810-25
Sponge Forceps
25 cm, 24.5 cm,



Rampley
UE-5-811-18
Sponge Forceps
18.5 cm, 24.5 cm,



Vickers
UE-5-901-18
Skin Hooklet
18.5 cm,



Vickers
UE-5-902-01
Bone Hooklet
17 cm,



Vickers
UE-5-903-01
Tendon Hooklet
17 cm,



Vickers
UE-5-904-02
Hooklet
16 cm,

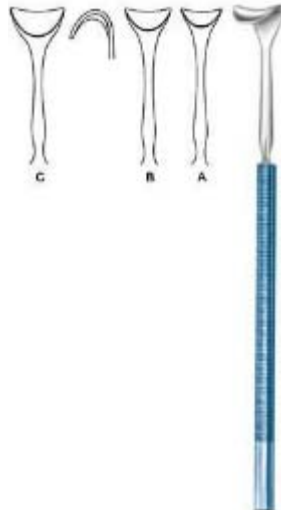

Vickers
UE-5-905-12
Saddle Hook
14 cm,



Graefe
UE-5-906-01
Micro Hooklet
15 cm,

Retractors

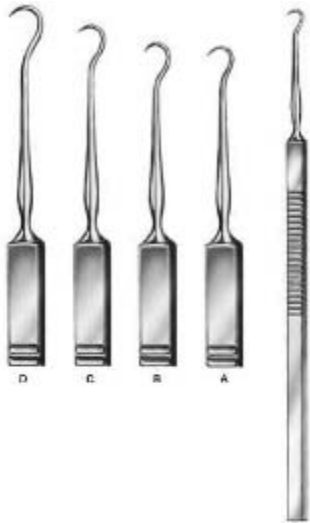

UE-5-907-01

Skin Hook

16 cm Fig. 1, 16 cm Fig. 2, 16 cm Fig. 3, 16 cm Fig. 4,



O Connor

UE-5-908-16

Skin Hook

16 cm,

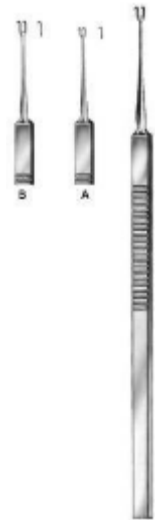

Guthrie

UE-5-909-01

Skin Hook

15.5 cm,



UE-5-910-01

Hooklet

16.5 cm,



UE-5-911-01

Hooklet

16.5 cm,



UE-5-912-02

Hooklet

16 cm,

Retractors



UE-5-913-04
Hooklet
16.5 cm,



UE-5-914-12
Vessel Hook
12 cm,



Desmarres
UE-5-915-08
Saddle Hook
16 cm 8 mm, 16 cm 10 mm, 16 cm 12 mm, 16 cm 14 mm, 16 cm 16 mm, 16 cm 18 mm,

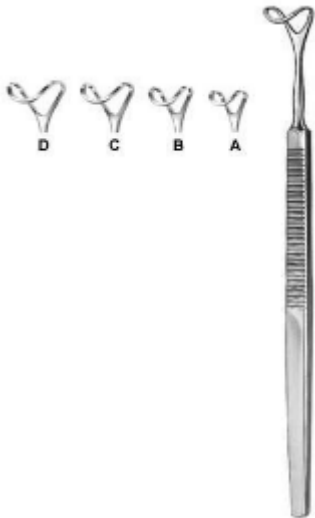

UE-5-916-12
Saddle Hook
16 cm 12 mm, 16 cm 14 mm, 16 cm 16 mm, 16 cm 18 mm,



Langenbeck-Mini
UE-5-917-10
Hooklet
16 cm,



UE-5-918-16
Hooklet
16 cm 14 x 8,



UE-5-919-01

Hooklet
16.5 cm,



UE-5-920-01

Hooklet
16.5 cm,



Meyerding

UE-5-921-01

Hooklet
17.5 cm Fig. 1, 17.5 cm Fig. 2, 17.5 cm Fig. 3, 17.5 cm Fig. 4, 17.5 cm Fig. 5, 17.5 cm Fig. 6,



Senn-Green

UE-5-922-01

Hooklet
15 cm Fig. 1, 15 cm Fig. 2,



Ragnell-Davis

UE-5-923-14

Hooklet
14 cm,

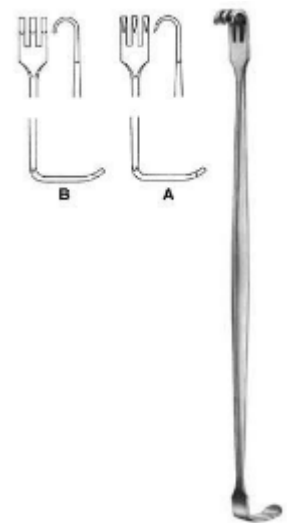

Senn-Miller

UE-5-924-16

Hooklet
16 cm,

Retractors



Cushing
UE-5-925-20
Retractor
20.5 cm,

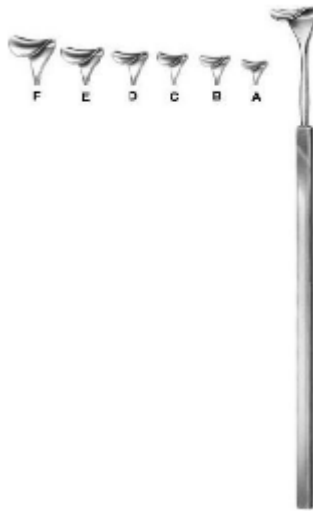

Cushing
UE-5-926-08
Saddle Hook
20.5 cm 8 mm wide, 20.5 cm 10 mm wide, 20.5 cm 12 mm wide, 20.5 cm 14 mm wide, 20.5 cm 16 mm wide, 20.5 cm 18 mm wide,

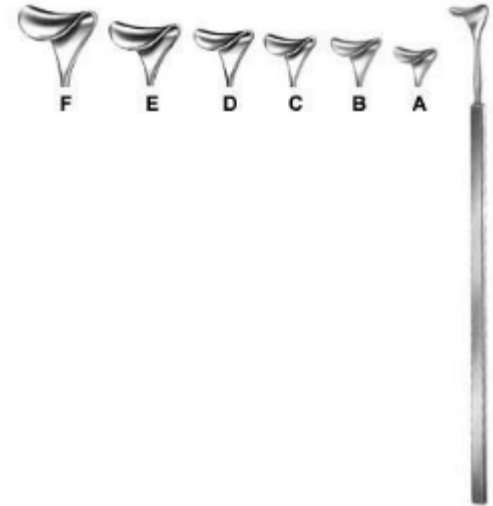

Cushing
UE-5-927-08
Saddle Hook 8 mm to 18 mm wide
24 cm,



Brom
UE-5-928-01
Vein Hook
19.5 cm,



Strandell-Stille
UE-5-929-01
Hooklet
19 cm Fig. 1, 19 cm Fig. 2,



Klapp
UE-5-930-01
Retractor 12 x 6, 12 x 11, 15 x 11
17.5 cm,

Retractors



UE-5-931-04

Hooklet
16.5 cm,

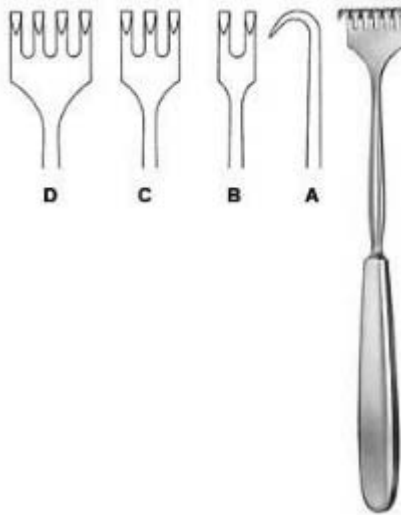

Volkmann
UE-5-932-01

Retractor
21.5 cm,



Volkmann

UE-5-933-01

Retractor
22 cm, 21.5 cm,



Kocher

UE-5-934-01

Retractor
22 cm,

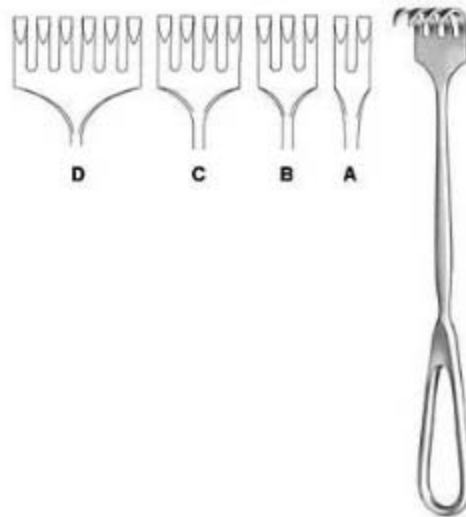

Martin

UE-5-935-02

Retractor
22.5 cm,

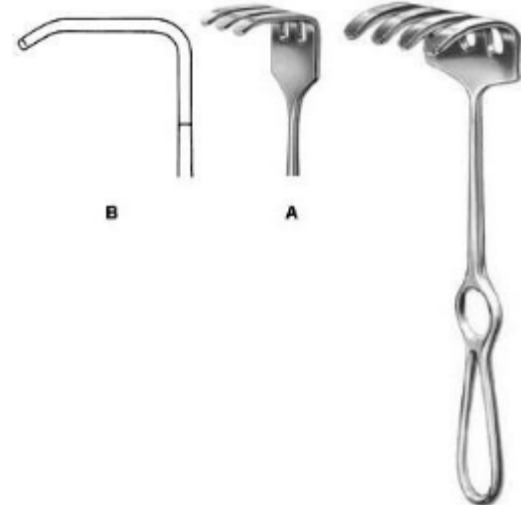

Ollier

UE-5-936-03

Retractor
23 cm 36 x 30, 23 cm 36 x 60,

Retractors



Wassmund
UE-5-937-02
Retractor
20.5 cm 33 x 21,

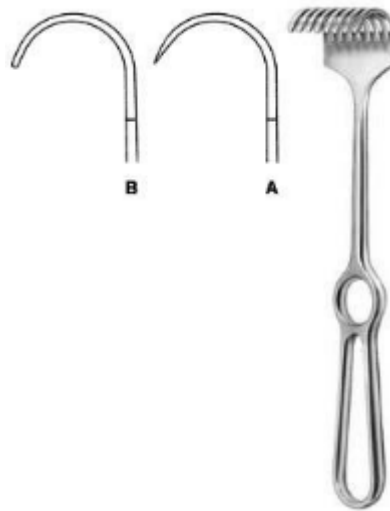

Korte
UE-5-938-08
Retractor
24.5 cm 40 x 30,

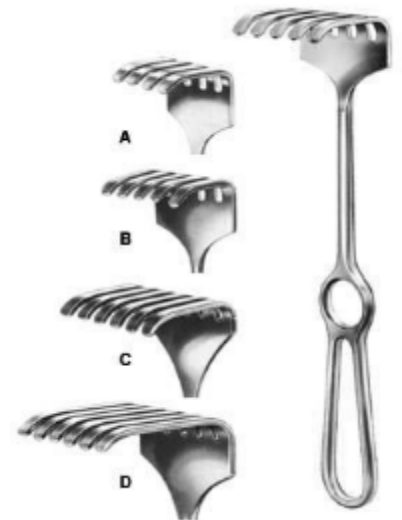

Israel
UE-5-939-04
Retractor
25.5 cm,

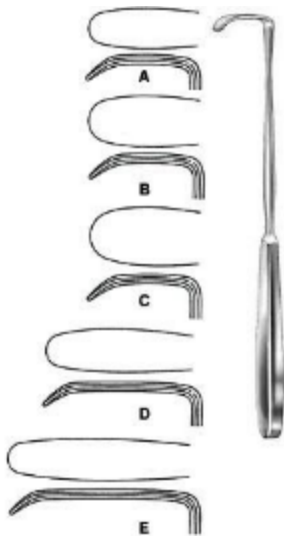

Langenbeck
UE-5-940-01
Retractor

22.5 cm 30 x 11 mm, 22.5 cm 30 x 14 mm, 22.5 cm 30 x 16 mm, 22.5 cm 40 x 11 mm, 22.5 cm 50 x 11 mm,

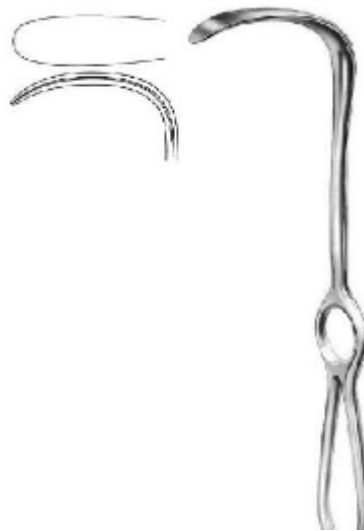

Langenbeck
UE-5-942-21
Retractor
21 cm 65 x 20 mm,



Langenbeck
UE-5-943-21
Retractor
22.5 cm 85 x 15 mm,

Retractors



Lahey

UE-5-944-19

Retractor

19.5 cm 36 x 19 mm,



Little

UE-5-945-20

Retractor

20 cm 13 x 15 mm,



Kocher

UE-5-946-18

Retractor

23 cm 43 x 18 mm, 23 cm 53 x 20 mm, 23 cm 63 x 25 mm, 23 cm 77 x 30 mm, 23 cm 78 x 40 mm,

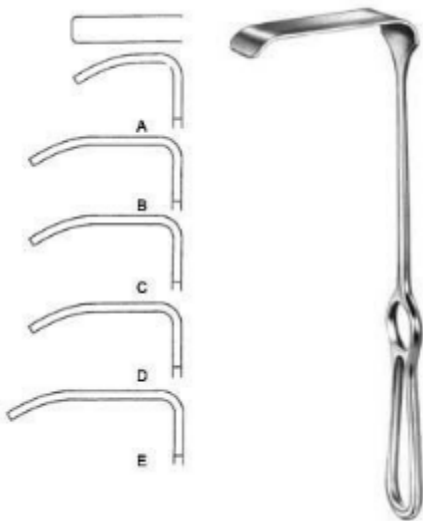

Kocher-Langenbeck

UE-5-947-01

Retractor

21.5 cm 25 x 6 mm, 21.5 cm 35 x 8 mm, 21.5 cm 35 x 11 mm, 21.5 cm 35 x 15 mm, 21.5 cm 40 x 11 mm, 21.5 cm 55 x 11 mm, 21.5 cm 70 x 14 mm, 21.5 cm 80 x 12 mm,

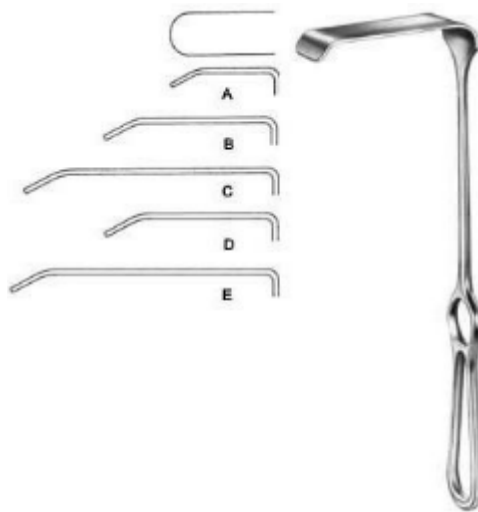

Kocher-Langenbeck

UE-5-948-01

Retractor

21.5 cm 25 x 10 mm, 21.5 cm 40 x 13 mm, 21.5 cm 60 x 13 mm, 21.5 cm 40 x 18 mm, 21.5 cm 60 x 18 mm, 21.5 cm 85 x 18 mm, 21.5 cm 60 x 25 mm, 21.5 cm 85 x 25 mm,

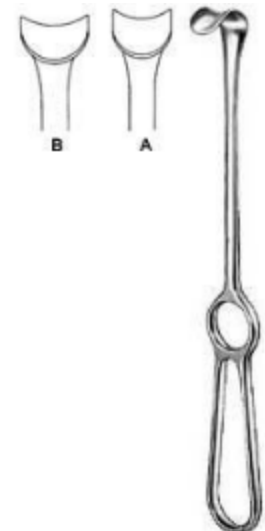

Kocher

UE-5-949-01

Retractor

21.5 cm 22 x 12 mm, 21.5 cm 24 x 14 mm,

Retractors

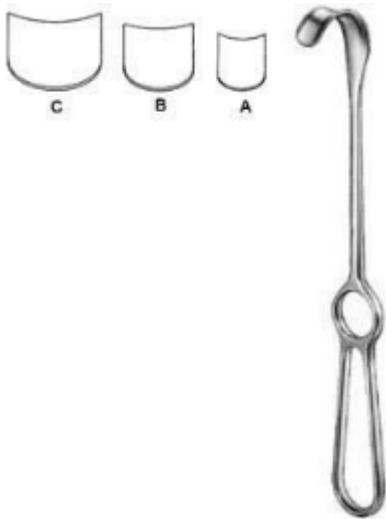

Kocher

UE-5-950-01

Retractor

22 cm 42 x 10 mm, 22 cm 42 x 15 mm, 22 cm 21.5 cm 18 x 17 mm, 23 cm 25 x 22 mm, 24.5 cm 43 x 20 mm,

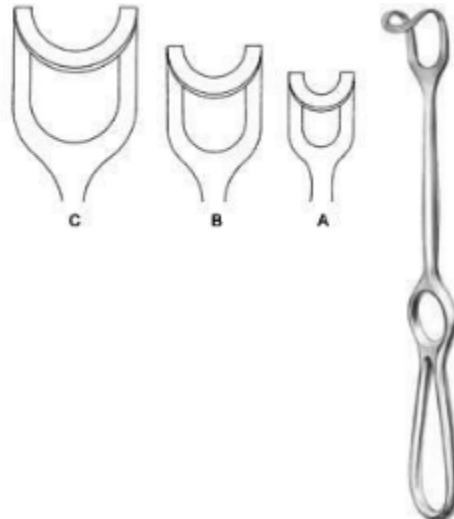

Middeldorpf

UE-5-951-01

Retractor

23 cm 25 x 22 mm, 24.5 cm 30 x 31 mm,



Doyen-Stillé

UE-5-952-01

Retractor

26 cm 97 x 29 mm, 26 cm 101 x 31 mm, 26 cm 127 x 52 mm,



Hosel

UE-5-953-01

Retractor

26 cm 63 x 21 mm, 26 cm 83 x 30 mm, 26 cm 103 x 30 mm, 26 cm 120 x 30 mm, 26 cm 140 x 30 mm, 26 cm 140 x 40 mm,

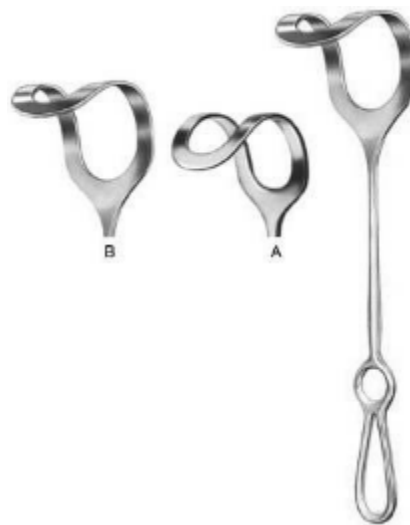

Middeldorpf

UE-5-954-01

Retractor

27 cm 48 x 45 mm, 27 cm 52 x 50 mm, 27 cm 60 x 70 mm,

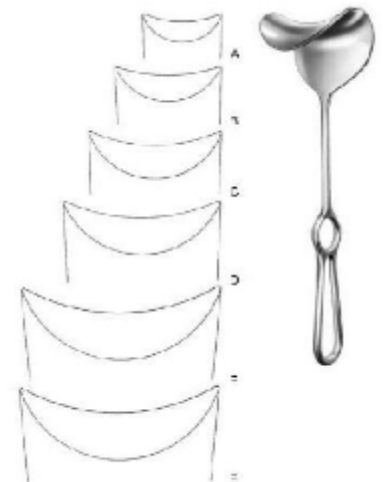

Fritsch

UE-5-955-00

Retractor

23.5 cm 37 x 31 mm, 24 cm 38 x 40 mm, 25 cm 43 x 51 mm, 25 cm 49 x 61 mm, 25.5 cm 48 x 75 mm, 25.5 cm 65 x 85 mm,

Retractors



Doyen

UE-5-956-25

Retractor
24 cm 48 x 88 mm,



Kocher

UE-5-957-22

Retractor
24 cm 73 x 25 mm,



Kocher

UE-5-958-01

Retractor
25 cm 80 x 45 mm, 25 cm 80 x 55 mm, 25 cm
80 x 65 mm,



Martin

UE-5-959-25

Retractor
26 cm 110 x 27 mm,

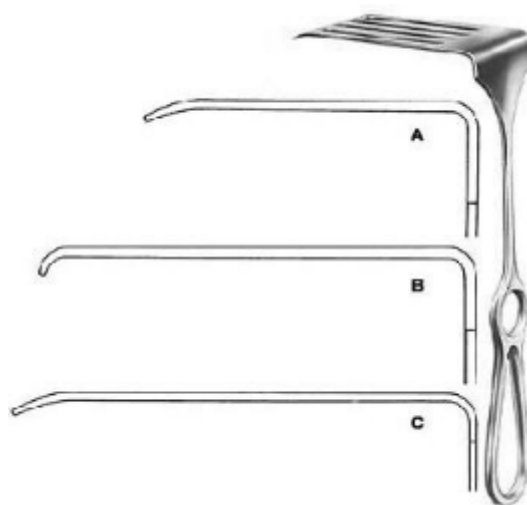

Coryllos

UE-5-960-01

Retractor
24 cm 85 x 22 mm, 24 cm 108 x 43 mm, 24
cm 119 x 65 mm,



Davidson

UE-5-961-01

Retractor
19 cm 80 x 54 mm, 18.5 cm 80 x 95 mm,

Retractors



Sauerbruch

UE-5-962-25

Retractor

25.5 cm 127 x 38 mm,

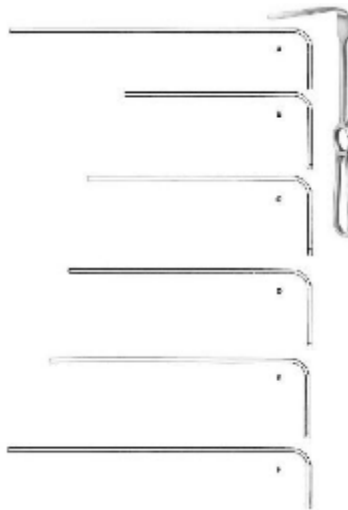

Brunner

UE-5-963-08

Retractor

25.5 cm 84 x 20 mm, 25.5 cm 104 x 25 mm, 25.5 cm 124 x 30 mm, 25.5 cm 130 x 30 mm, 25.5 cm 144 x 30 mm, 25.5 cm 160 x 30 mm, 25.5 cm 164 x 30 mm,

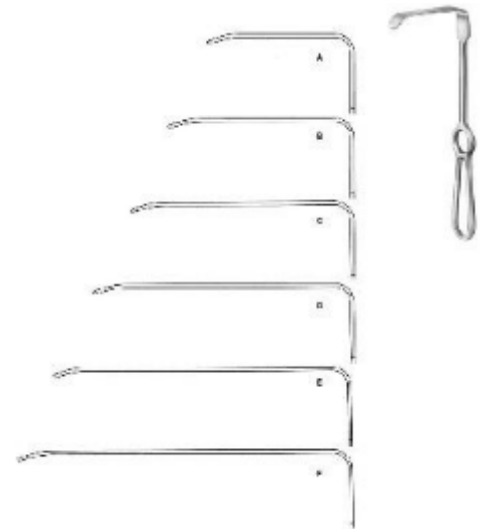

Brunner

UE-5-964-08

Retractor

25.5 cm 82 x 20 mm, 25.5 cm 102 x 20 mm, 25.5 cm 122 x 25 mm, 25.5 cm 140 x 25 mm, 25.5 cm 162 x 30 mm, 25.5 cm 182 x 30 mm,

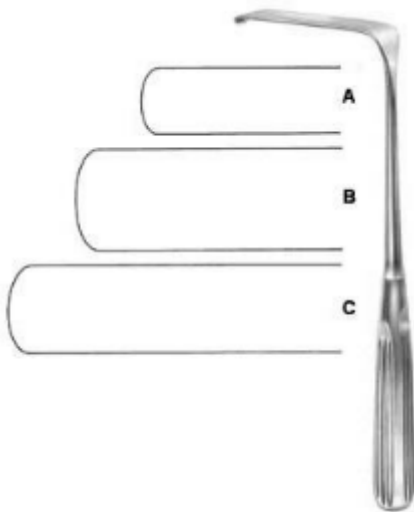

Sauerbruch

UE-5-965-01

Retractor

22.5 cm 50 x 15mm, 22.5 cm 63 x 23mm, 22.5 cm 80 x 20mm,



Deaver

UE-5-966-01

Retractor

18 cm 19mm,



Mikulicz

UE-5-968-01

Retractor

25 cm 90 x 35mm, 25 cm 125 x 50mm, 25 cm 160 x 50mm,

Retractors



Mikulicz
UE-5-969-26
Retractor
26 cm 90 x 55mm,

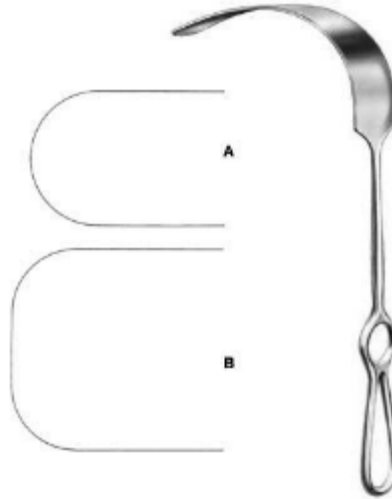

Kelly
UE-5-970-01
Retractor
27.5 cm 205 x 38mm, 27.5 cm 205 x 57mm,



Farabeuf
UE-5-971-00
Retractor
15 cm Fig. 1 = 23 x 16, 15 cm Fig. 1 = 26 x 16, 15 cm Fig. 2 = 27 x 16, 15 cm Fig. 2 = 30 x 16,

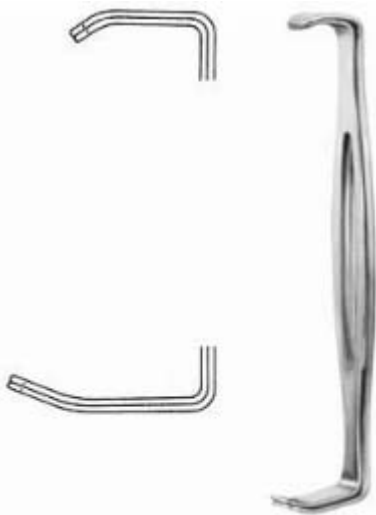

Parker-Langenbeck
UE-5-972-00
Retractor
21.5 cm Fig. 1 = 21x15mm, 21.5 cm Fig. 1 = 40x15mm, 21.5 cm Fig. 2 = 25x15mm, 21.5 cm Fig. 2 = 45x15mm,



Alm
UE-5-973-07
Wound Spreaders, self-retaining
7 cm,



Alm
UE-5-974-07
Wound Spreaders, self-retaining
7 cm,

Retractors



Gosset

UE-5-975-22

Abdominal Retractor
18.5 cm,



Balfour-Baby

UE-5-976-00

Abdominal Retractor spreading 90mm, 1
central blade 24 x 20mm
12.5 cm,



Balfour

UE-5-977-00

Abdominal Retractor spreading 180mm,
lateral blades 70 x 35mm, 1 central blade
20 cm,



Deaver

UE-5-967-04

Retractor
31.5 cm 25mm, 31.5 cm 38mm, 31.5 cm
50mm, 31.5 cm 100mm,

Probes



UE-5-1001-11

Probe

11.5 cm, 13 cm, 14.5 cm, 16 cm, 18 cm, 20 cm, 25 cm, 30 cm,



UE-5-1002-11

Probe

11.5 cm, 13 cm, 14.5 cm, 16 cm, 18 cm, 20 cm, 25 cm, 30 cm,

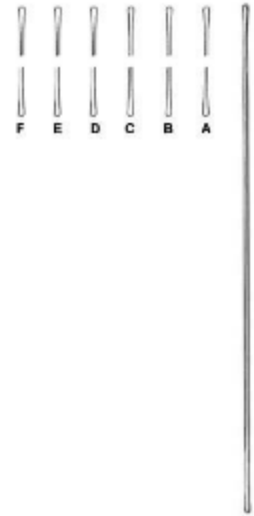

UE-5-1003-13

Probe

13 cm, 14.5 cm, 16 cm, 18 cm, 20 cm, 25 cm,



UE-5-1004-13

Probe with eye

13 cm, 14.5 cm, 16 cm,



UE-5-1006-13

Myrtle Leaf Probe

13 cm, 14.5 cm, 16 cm, 18 cm, 20 cm,



UE-5-1007-13

Grooved Director

13 cm, 14 cm, 16 cm,



UE-5-1008-13

Grooved Director
13 cm, 14.5 cm, 16 cm,



Doyen

UE-5-1009-14

Grooved Director
14.5 cm,



Nelaton

UE-5-1010-16

Grooved Director
16 cm,

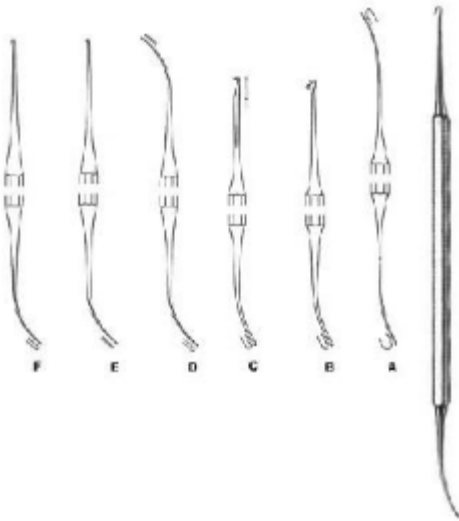

Varady

UE-5-1011-01

Phlebodissector
18 cm, 17.5 cm,

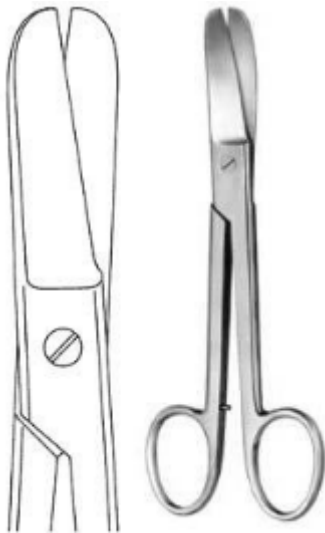

Lorenz

UE-6-101-23

Bandage Scissors heavy pattern
23 cm,



Lister

UE-6-102-14

Bandage Scissors
14.5 cm, 18.5 cm, 20 cm,



Bergmann

UE-6-103-23

Plaster Shears
23.5 cm,



Esmarch

UE-6-104-20

Plaster Shears heavy pattern, short blades
20 cm,



UE-6-105-15

Bandage Scissors black plastic ring with
autodavable
16 cm, 19 cm,



UE-6-106-18

Bandage Scissors black plastic rings
19 cm, 16 cm,

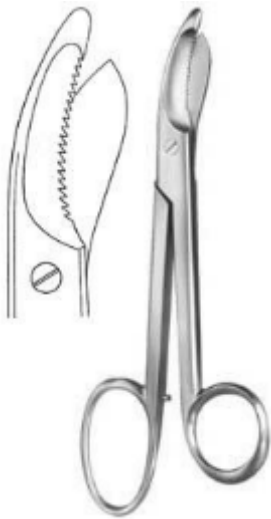

Brun's
UE-6-107-24
Plaster Scissors
24 cm,



Stille-Martin
UE-6-108-23
Plaster Shears
23 cm, 27 cm, 38 cm,

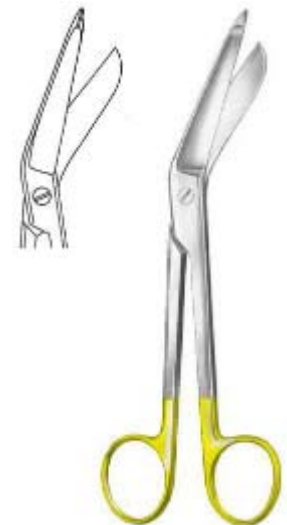

Lister
UE-6-109-18
Bandage Scissors
18 cm,



Brun's
UE-6-110-24
Plaster Scissors
24 cm,



Hopkins
UE-6-111-20
Plaster Knife with wooden handle
20 cm,



Reiner
UE-6-112-18
Plaster Knife
18 cm,



Reiner
UE-6-113-18
Plaster Knife
18 cm,



Martin
UE-6-114-21
Plaster Knife with wooden handle
21 cm,



Engel
UE-6-115-14
Plaster Saw
15.5 cm,

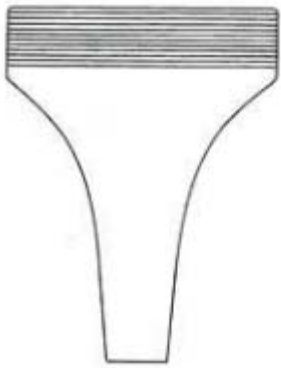

Hennig
UE-6-116-28
Plaster Spreader
28 cm,

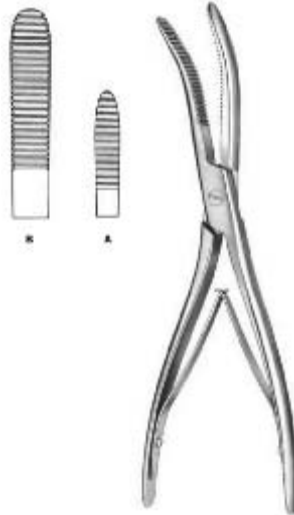

Wolff
UE-6-117-18
Plaster Breaker
18 cm, 26.5 cm,



Gigli

UE-8-101-01

Wire Saw Handle



De Martel

UE-8-102-33

Wire Saw Guide
33 cm,



Crutchfield

UE-8-103-01

Skull Traction Tong small pattern



UE-8-104-01

Skull Traction Tong large pattern
22.5 cm,



Dahlgren

UE-8-105-20

Cranial Rongeur
20 cm,



Olivecrona-Toennis

UE-8-106-14

Clip Applying Forceps



McKenzie
UE-8-107-19
Clip Applying Forceps
18.5 cm,



Olivecrona
UE-8-108-18
Dura Dissector
18 cm,



Olivecrona
UE-8-109-19
Dura Dissector
20 cm,



Milligan
UE-8-110-21
Dura Dissector
21.5 cm,



Davis
UE-8-111-21
Dura Dissector sharp
21.5 cm,



UE-8-112-22
Dura Dissector
22 cm,



Davis

UE-8-113-24

Dura Dissector
24.5 cm,



Love

UE-8-114-19

Nerve Root Retractor
21.5 cm, 18 cm, 11 cm,



Olivecrona

UE-8-115-18

Brain Spatula
18 cm,



Scoville

UE-8-116-23

Nerve Root Retractor 8mm
23.5 cm,



Holsher

UE-8-117-24

Nerve Root Retractor 8mm
23.5 cm,



Scoville

UE-8-118-19

Nerve Root Retractor 7mm
16.5 cm,



Groningen
UE-8-119-26
Nerve Hook
26.5 cm,



Groningen
UE-8-120-26
Nerve Hook
26.5 cm,



Cushing
UE-8-121-19
Nerve Hook blunt
19 cm, 28 cm,

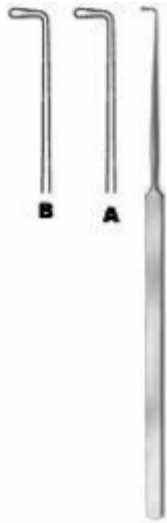

Cushing
UE-8-122-19
Nerve Hook
19.5 cm, 28 cm,



Smithwick
UE-8-123-17
Nerve Hook
17 cm, 21 cm,



Halle
UE-8-125-20
Dura Knife
20 cm,



Adson
UE-8-126-20
Dura Hook
20 cm,



Graham
UE-8-127-16
Dura Hook blunt
16.5 cm,



Sachs
UE-8-128-18
Dura Hook sharp
18 cm,



Toennis
UE-8-129-15
Dura Hook sharp
14.5 cm,



Frazier
UE-8-130-13
Dura Hook sharp
13 cm, 18 cm,



Krayenbuhl
UE-8-131-01
Nerve and Vessel Hooklet
18.5 cm Fig. 1, 18.5 cm Fig. 2,



Cloward

UE-8-132-16

Lamina Spreader
16 cm,

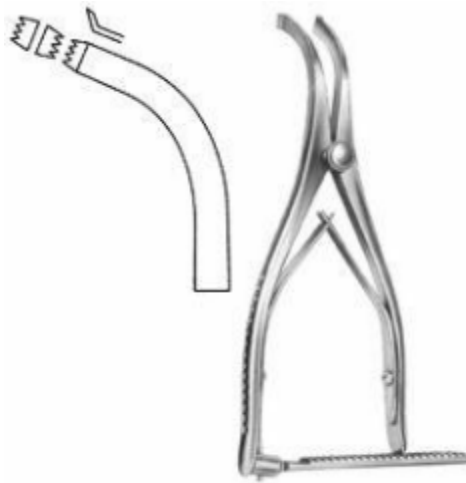

Inge

UE-8-133-17

Lamina Spreader
16 cm,



Inge

UE-8-134-27

Lamina Spreader
25.5 cm,

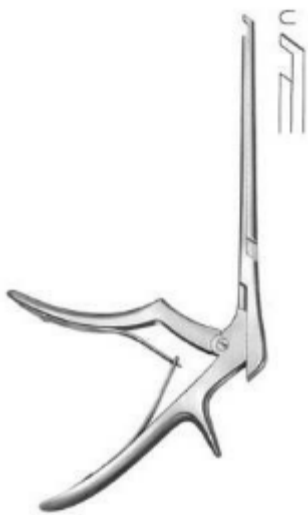

Ferris-Smith Kerrison

UE-8-135-03

Laminectomy Punch 3mm downwards cutting
40 degree shaft length 180 mm



Ferris-Smith Kerrison

UE-8-138-01

Laminectomy Punch upwards cutting shaft
length 180 mm
1 mm, 2 mm, 3 mm, 4 mm, 5 mm, 6 mm,

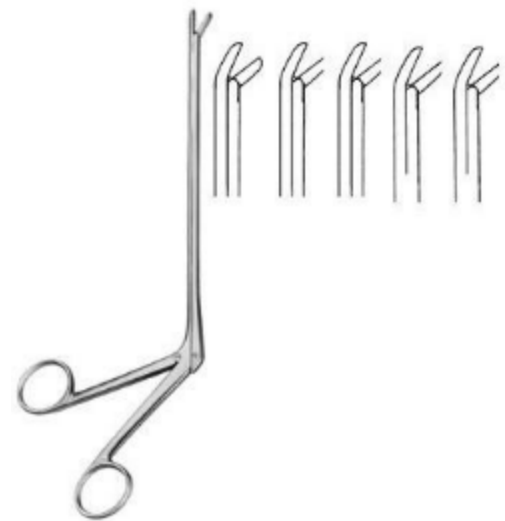

Cushing

UE-8-139-01

Laminectomy Rongeur jaw 2 x 10 to 4 x 10
mm straight shaft length 180 mm

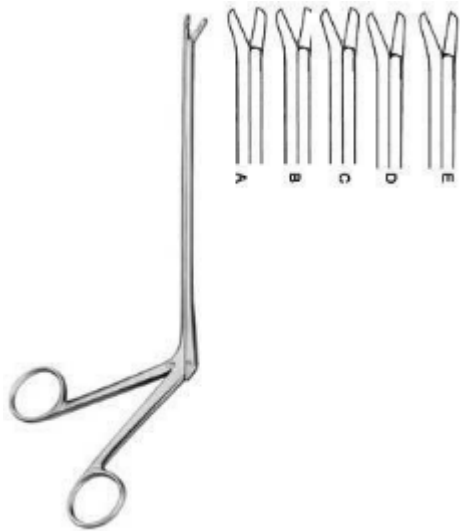

Cushing

UE-8-140-01

Laminectomy Rongeur jaw 2 x 10 to 4 x 10 mm upwards 45 degree shaft length 120 mm



Ferris-Smith Kerrison

UE-8-137-01

Laminectomy Punch
1 mm, 2 mm, 3 mm, 4 mm, 5 mm, 6 mm,



UE-9-101-23
Bone Shear
23 cm,



UE-9-102-22
Rib Shear
23 cm,



Gluck
UE-9-103-22
Rib Shears
21 cm,



Giertz-Stille
UE-9-104-27
Rib Shear
24.5 cm,



Lebsche
UE-9-105-24
Sternum Chisel
24.5 cm,



UE-9-106-01
Rib Retractor lateral blades 12 x 16 mm
spreading 95 mm
Size 1,

Cardiovascular



Finochietto, Infant
UE-9-107-01

Rib Retractor lateral blades 15 x 15 mm
spreading 75 mm
Size 1,



Finochietto, Baby
UE-9-108-01

Rib Retractor lateral blades 31 x 31 mm
spreading 100 mm
Size 1,



Finochietto
UE-9-109-01

Rib Retractor lateral blades 40 x 45 mm
spreading 135 mm
Size 1,



Burford
UE-9-110-01

Rib Retractor with two pairs of blades 47 x
62 mm + 65 x 62 mm, spreading 200 mm
Size 1,



Castaneda
UE-9-111-01

Rib Retractor lateral blades 10,5 x 32 mm
spreading 65 mm
Size 1,



Finochietto (modif.)
UE-9-112-01

Rib Retractor lateral blades 14 x 15 mm
spreading 120 mm
Size 1,



Haight

UE-9-113-90

Rib Retractor lateral blades 30 x 30 mm spreading 120 mm
Size 1,



Morse-Favaloro

UE-9-114-01

Sternal Retractor 4 movable blades 17 x 22 mm spreading 160 mm Sternal Retractor
Size 1,



Morse

UE-9-115-00

Sternal Retractor 4 movable blades 22 x 27 mm spreading 200 mm
Size 1,



Tuffier

UE-9-116-02

Rib Retractor lateral blades 22 x 27 mm spreading 200 mm
Size 1,

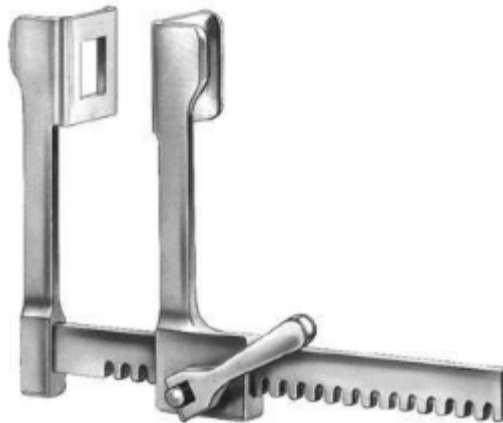

Finochietto, Baby

UE-9-117-75

Rib Retractor lateral blades 14 x 15 mm spreading 75 mm
Size 1,



Finochietto

UE-9-118-01

Rib Retractor lateral blades 30 x 45 mm spreading 150 mm
Size 1,

Cardiovascular



DeBakey

UE-9-119-00

Rib Retractor spreading 150 mm
Size 1,



DeBakey

UE-9-120-00

Rib Retractor spreading 200 mm
Size 1,



UE-9-121-00

Thoracic Retractor
Size 1,



Sellors

UE-9-122-19

Rib Contractor
20 cm,



Bailey-Baby

UE-9-123-14

Rib Contractor
15.5 cm,



Bailey

UE-9-124-16

Rib Contractor
20 cm,

Cardiovascular



Bailey-Gibbon
UE-9-125-16
Rib Contractor
20 cm,



Allison
UE-9-126-30
Lung Spatula
29.5 cm, 32.5 cm,



Price-Thomas
UE-9-127-22
Bronchus Clamp
22 cm,



Price-Thomas
UE-9-128-22
Bronchus Clamp
22 cm,

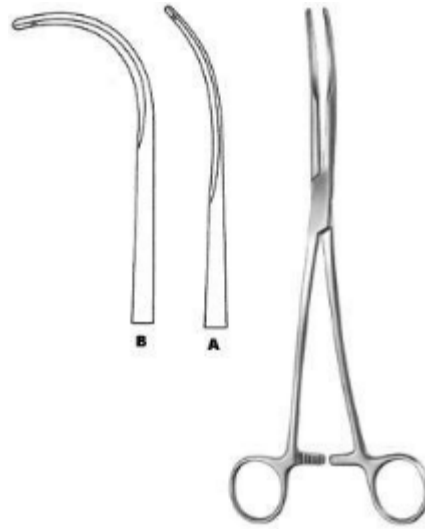

Semb
UE-9-129-24
Bronchus Clamp
24.5 cm,



Lovelace
UE-9-130-20
Lung Grasping Forceps
20.5 cm,



Lovelace

UE-9-131-20

Lung Grasping Forceps
19 cm,



DeBakey-Satinsky

UE-9-132-07

Bulldog Clamp
7 cm, 9 cm,



Glover

UE-9-133-06

Bulldog Clamp
6 cm,



Santulli

UE-9-134-07

Bulldog Clamp
7 cm,



Gregory, soft

UE-9-135-09

Bulldog Clamp
9 cm, 11 cm,



Gregory

UE-9-136-01

Bulldog Clamp
10.5 cm,

Cardiovascular

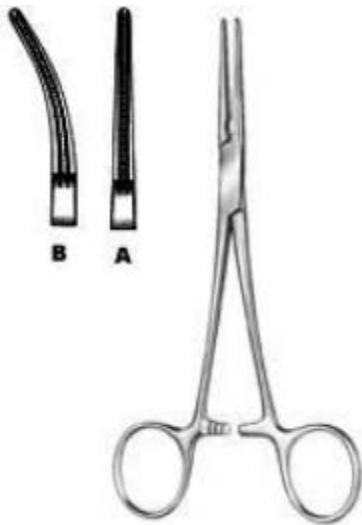

DeBakey-Rankin

UE-9-137-16

Haemostatic Forceps
16 cm,



DeBakey-Mosquito

UE-9-138-15

Haemostatic Forceps
15 cm,



Ochsner

UE-9-139-23

Aortic Clamp
23.5 cm,



Diethrich

UE-9-140-21

Aortic Clamp
22 cm,

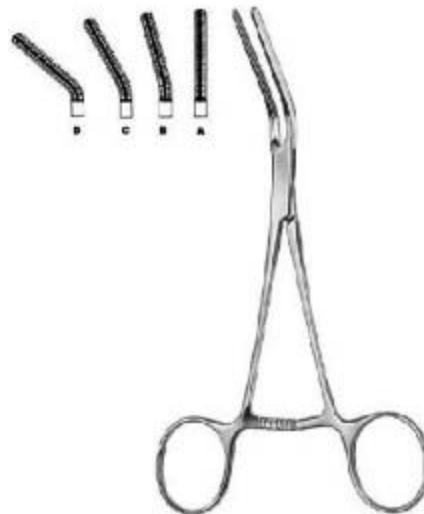

Dardik

UE-9-141-00

Multi purpose Vascular Clamp
15 cm,



Dale

UE-9-142-18

Peripheral Vascular Clamp
18 cm,

Cardiovascular

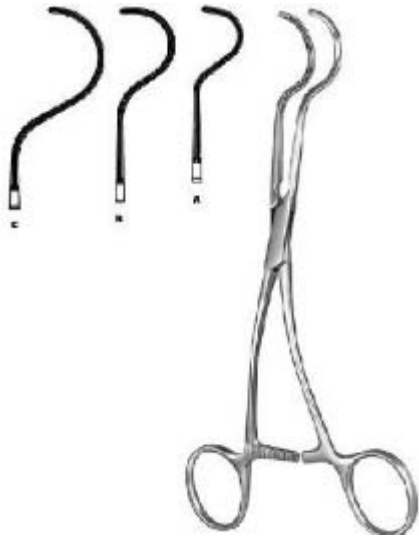

Dale

UE-9-143-17

Peripheral Vascular Clamp
17.5 cm,

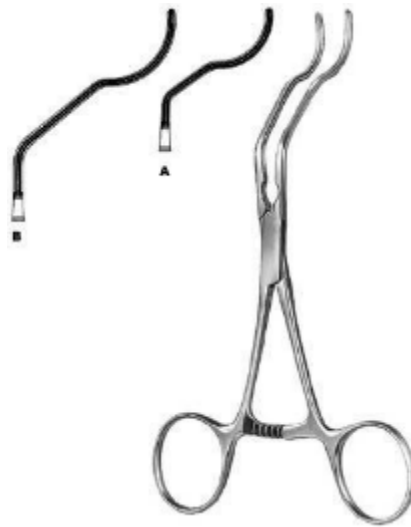

Gregory

UE-9-144-14

Profunda Clamp
13 cm, 16 cm, 18 cm,

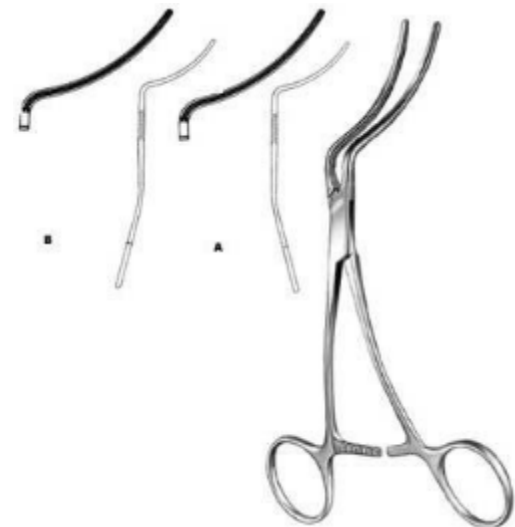

Martin

UE-9-145-16

Peripheral Vascular Clamp
16.5 cm,



Husfeldt

UE-9-146-18

Peripheral Vascular Clamp
17.5 cm,



Husfeldt

UE-9-147-18

Peripheral Vascular Clamp
18 cm,



Husfeldt

UE-9-148-17

Peripheral Vascular Clamp
17 cm,

Cardiovascular



DeBakey
UE-9-149-16
Vascular Forceps
16 cm,



DeBakey
UE-9-150-16
Vascular Forceps
16 cm,



DeBakey
UE-9-151-16
Vascular Forceps
16 cm,



DeBakey
UE-9-152-16
Vascular Forceps
16 cm,



DeBakey
UE-9-153-16
Vascular Forceps
16 cm,



DeBakey
UE-9-154-07
Bulldog Clamp
7.5 cm,



DeBakey
UE-9-155-07
Bulldog Clamp
7.5 cm,



UE-9-156-23
Applying Forceps
23.5 cm,



Glover
UE-9-157-06
Bulldog Clamp
7 cm,



Glover
UE-9-158-06
Bulldog Clamp
6.5 cm,



Potts
UE-9-159-21
Coarctation Clamp
21 cm,

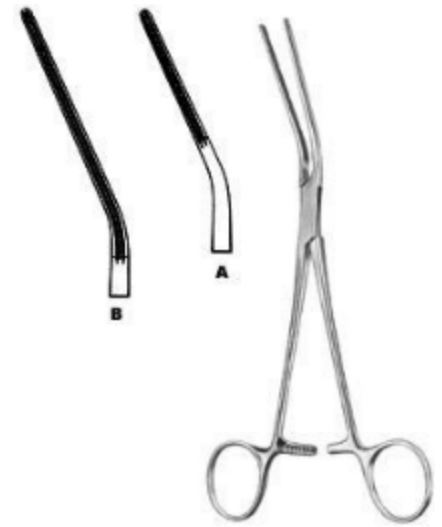

Potts
UE-9-160-21
Coarctation Clamp
20.5 cm,

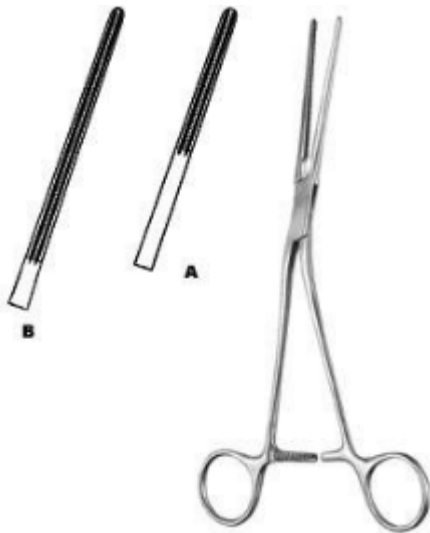

Potts

UE-9-161-21

Coarctation Clamp
20.5 cm,



Potts

UE-9-162-22

Anastomosis Clamp
21.5 cm,



Potts

UE-9-163-22

Anastomosis Clamp
22 cm,



DeBakey

UE-9-164-19

Ligature Forceps
19 cm,



DeBakey

UE-9-165-16

Peripheral Vascular Clamp
16 cm,



DeBakey

UE-9-166-19

Peripheral Vascular Clamp
16 cm,

Cardiovascular

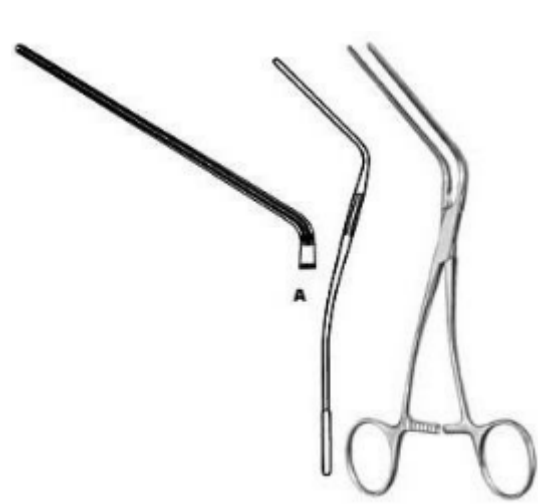

Leland-Jones

UE-9-167-18

Peripheral Vascular Clamp
18 cm,



Bainbridge

UE-9-168-15

Multi purpose Vascular Clamp
15 cm,



Bainbridge

UE-9-169-15

Multi purpose Vascular Clamp
15 cm,

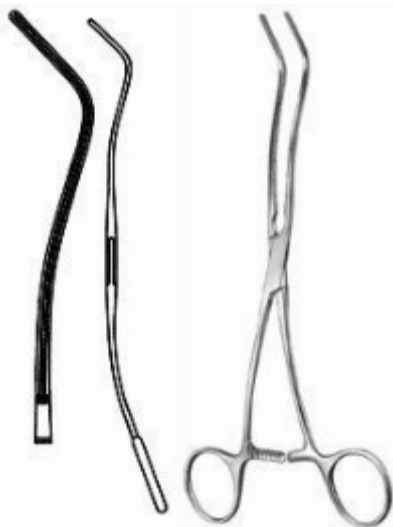

DeBakey

UE-9-170-20

Multi purpose Vascular Clamp
20 cm,



DeBakey

UE-9-171-26

Aortic Aneurysm Clamp
26 cm,



DeBakey

UE-9-172-28

Aortic Aneurysm Clamp
28 cm,

Cardiovascular



DeBakey

UE-9-173-30

Aortic Aneurysm Clamp
30 cm,



DeBakey

UE-9-174-27

Aortic Clamp
27 cm,



DeBakey

UE-9-175-24

Ligature Forceps
24.5 cm,



DeBakey

UE-9-176-24

Ligature Forceps
24.5 cm,



DeBakey

UE-9-178-25

Ligature Forceps
27 cm,

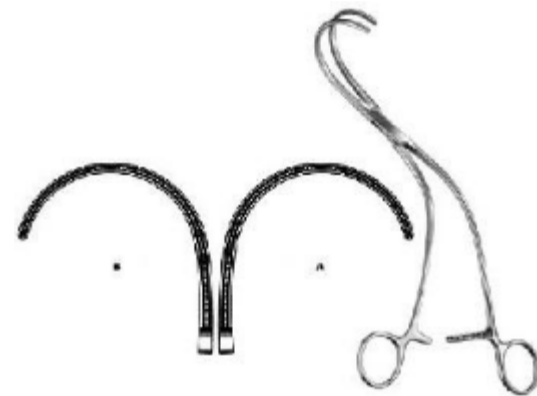

Weber

UE-9-179-01

Aortic Clamp
24 cm,

Cardiovascular



Satinsky

UE-9-180-20

Tangential Occlusion Clamp
22 cm,



Harken

UE-9-181-01

Auricle Clamp
24.5 cm,



Lees

UE-9-182-23

Bronchus Clamp
23 cm,



Lees

UE-9-183-25

Bronchus Clamp
25 cm,



Lambert-Kay

UE-9-184-21

Anastomosis Clamp
22.5 cm,



DeBakey

UE-9-185-17

Anastomosis Clamp
16.5 cm,

Cardiovascular



Morris-DeBakey
UE-9-186-18
Aortic Clamp
16.5 cm,



DeBakey-Bahnsen
UE-9-187-23
Aneurysm Clamp
23.5 cm,

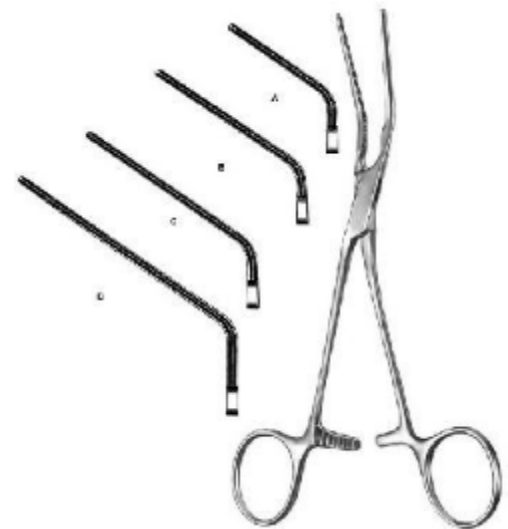

DeBakey
UE-9-188-20
Multi purpose Vascular Clamp
18 cm,

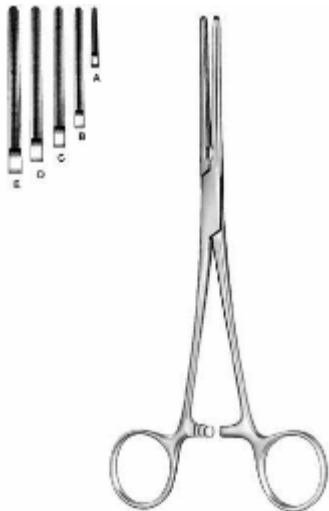

DeBakey-Mosquito
UE-9-189-12
Haemostatic Forceps
12.5 cm,



DeBakey-Mosquito
UE-9-190-12
Haemostatic Forceps
12.5 cm,



DeBakey
UE-9-191-17
Multi purpose Vascular Clamp
17 cm,

Cardiovascular



DeBakey

UE-9-192-16

Multi purpose Vascular Clamp
16.5 cm,

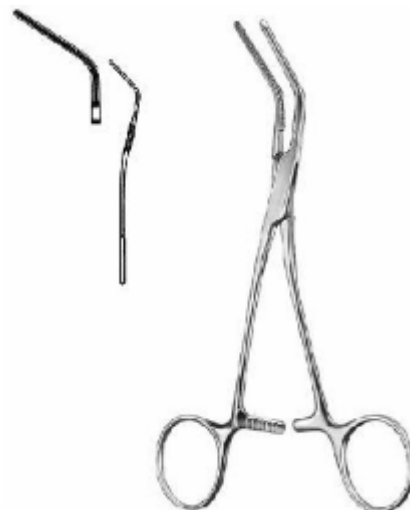

DeBakey

UE-9-193-15

Multi purpose Vascular Clamp
16 cm,



DeBakey

UE-9-194-15

Multi purpose Vascular Clamp
16.5 cm,



DeBakey

UE-9-195-17

Multi purpose Vascular Clamp
16.5 cm,



Glover

UE-9-196-17

Multi purpose Vascular Clamp
17 cm,



Glover

UE-9-197-17

Multi purpose Vascular Clamp
17.5 cm,

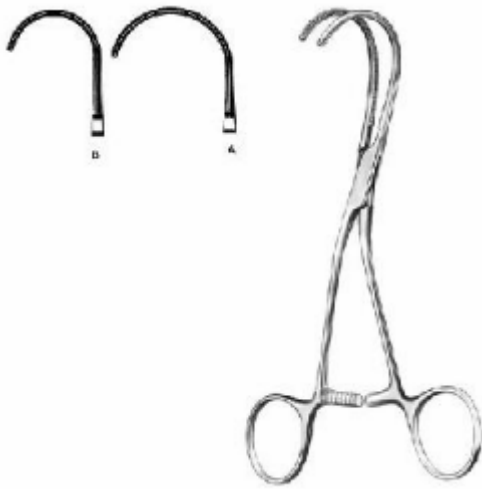

DeBakey

UE-9-198-16

Multi purpose Vascular Clamp
16.5 cm,

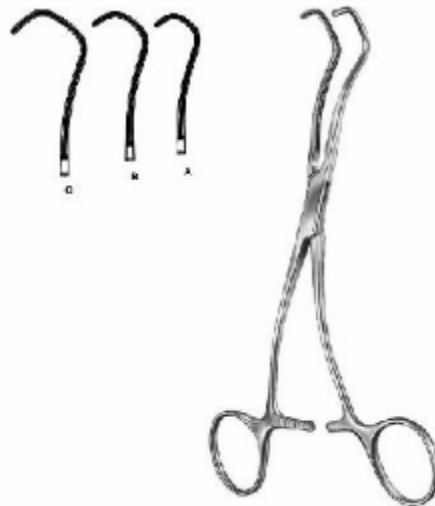

Derra

UE-9-199-16

Anastomosis Clamp
16.5 cm Fig. 1, 17 cm Fig. 2, 18 cm Fig. 3,



DeBakey-Beck

UE-9-200-17

Anastomosis Clamp
17 cm,



Cooley

UE-9-201-16

Vascular Forceps
16 cm,

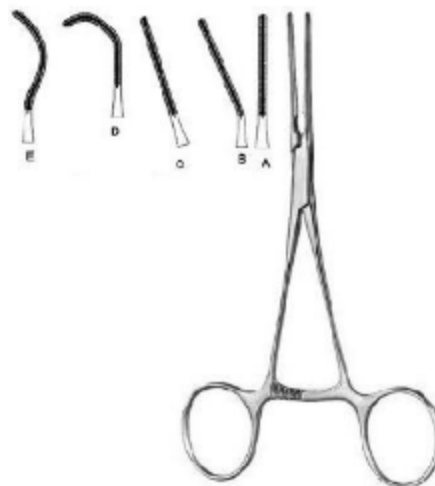

Cooley

UE-9-202-01

Pediatric Vascular Clamp
14.5 cm,



Cooley

UE-9-203-21

Iliac Clamp
22 cm,

Cardiovascular



Cooley
UE-9-204-17
Anastomosis Clamp
17 cm,

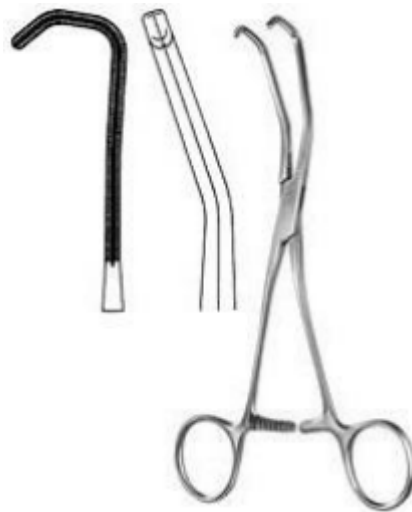

Cooley
UE-9-205-17
Anastomosis Clamp
20 cm,



Cooley
UE-9-206-16
Anastomosis Clamp
17 cm,



Cooley
UE-9-207-15
Multi purpose Vascular Clamp
16 cm,



Cooley
UE-9-208-17
Multi purpose Vascular Clamp
17 cm,



Cooley
UE-9-209-17
Multi purpose Vascular Clamp
17 cm,

Cardiovascular



Cooley
UE-9-210-17
Multi purpose Vascular Clamp
17.5 cm,



Cooley
UE-9-211-16
Multi purpose Vascular Clamp
16.5 cm,



Cooley-Derra
UE-9-212-16
Anastomosis Clamp
16.5 cm,



Cooley-Beck
UE-9-213-17
Anastomosis Clamp
17 cm,

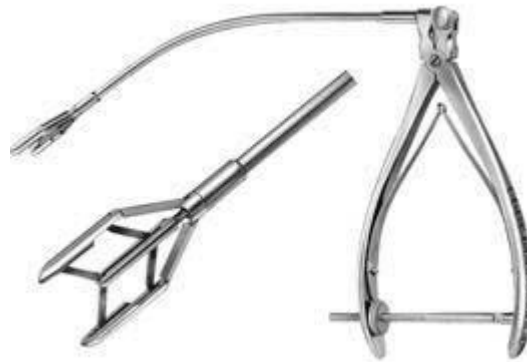

Cooley
UE-9-214-00
Aortic Dilator



Cooley
UE-9-215-05
Vascular Dilator
13 cm 0,5 mm ?,

Cardiovascular



DeBakey

UE-9-216-05

Vascular Dilator
19 cm 0,5 mm ?,



Martin

UE-9-217-00

Tunneling Set complete set with three shafts,
two handles and 12 tips in storage case.



Hach

UE-9-218-01

Fasciotomy Knife with plastic handle
30 cm,



UE-9-219-18

Intima Spatula
18.5 cm,

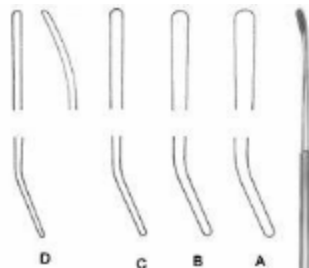

Robb

UE-9-220-01

Vascular Dissector
24 cm Fig. 1 2,5 mm ?, 24 cm Fig. 2 2,0
mm ?,



Crile

UE-9-221-20

Nerve Hooklet
20 cm,

Cardiovascular

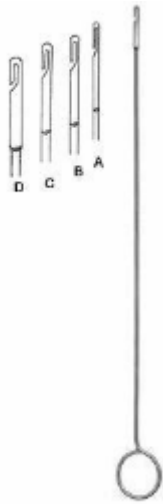

UE-9-222-15
Ligature Catcher
26 cm 1,5 mm,



Subramanian-Miniature
UE-9-223-15
Aortic Clamp 135 degree
15.5 cm,

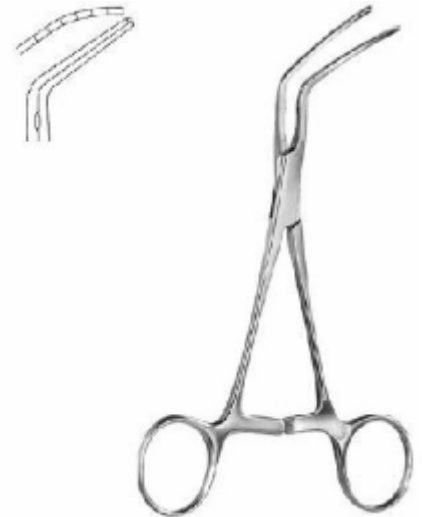

Subramanian
UE-9-224-16
Aortic Clamp
16 cm,

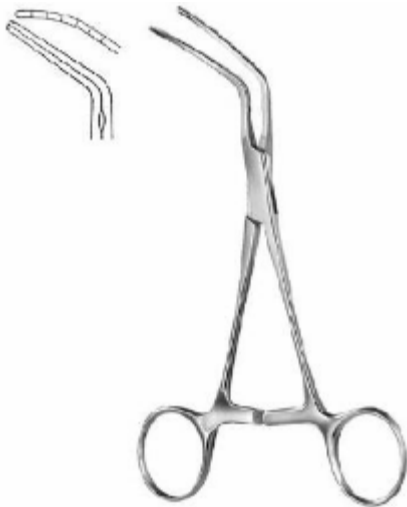

Subramanian
UE-9-225-16
Aortic Clamp

13.5 cm Fig. 1, 13.5 cm Fig. 2, 14 cm Fig. 3,

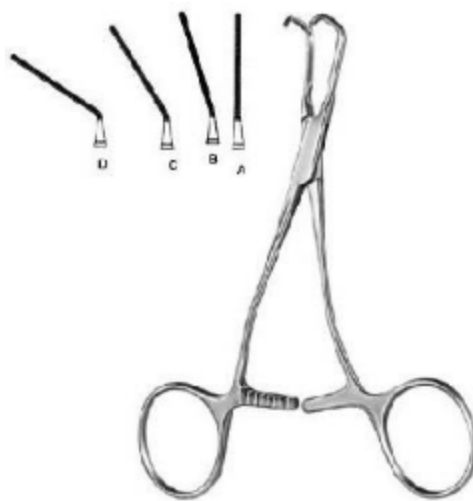

UE-9-226-01
Pediatric Vascular Clamp



UE-9-227-16
Pediatric Vascular Clamp
16.5 cm,



UE-9-228-16

Pediatric Vascular Clamp
16 cm,



Barraquer (Colibri)

UE-11-101-03

Barraquer
Size 1,



UE-11-102-07

Bowman
Size 1,



UE-11-103-06

Critchett
Size 1,



UE-11-104-05

Smith
Size 1,



UE-11-105-08

Clark
Size 1,



UE-11-106-06

Graefe
Size 1,



UE-11-107-08

Week
Size 1,



UE-11-108-07

Arruga
Size 1,



UE-11-109-07

Arruga
Size 1,



UE-11-110-05

Murdock
Size 1,



Millinger

UE-11-111-07

Mellinger Axenfeld
Size 1,



Millinger

UE-11-112-07

Mellinger Axenfeld
Size 1,



Millenger
UE-11-113-07
Mellinger
Size 1,



UE-11-114-08
Lister Burch
Size 1,



Williams Eye Speculum
UE-11-115-08
Williams
7 cm, 8.3 cm,



Lancaster
UE-11-116-07
Lancaster
Size 1,



UE-11-118-08
Ziegler
Size 1,



Mueller
UE-11-120-07
Mueller
Size 1,

Ophthalmology



Jaeger Lid Plate

UE-11-121-11

Jaeger
4", 20mm, 23mm,



VON GRAEFE Knife

UE-11-122-03

Graefe
1, 2, 3, 4, 5,



UE-11-123-01

Jaeger
Size 1,



ZIEGLER knife Needle

UE-11-126-01

Ziegler
11.4 cm,

UE-11-124-13

Berens
Size 1,



Castroviejo Cyclodialysis Spatula

UE-11-127-12

Castroviejo
13.3 cm,



UE-11-128-12

Wheeler
Size 1,



Castroviejo Cyclodialysis Spatula

UE-11-129-05

Castroviejo
Size 1,



UE-11-130-12

Dix
Size 1,



UE-11-131-13

Dix
Size 1,



UE-11-132-13

Dix
Size 1,



Castroviejo Caliper

UE-11-133-07

Castroviejo
8.3 cm,



UE-11-134-13
Connin Amsler
Size 1,



UE-11-135-06
Dastoor
Size 1,



UE-11-136-09
Holth
Size 1,



Wilder Lacrimal Dilator
UE-11-137-03
Wilder
10.2 cm,



ZIEGLER Lacrimal Dilator
UE-11-138-12
Ziegler
14 cm Double End,



Castroviejo Lacrimal Dilator
UE-11-139-12
Castroviejo
14 cm,



UE-11-140-78

Bowman
Size 1,



UE-11-141-07

Graefe
Size 1,



UE-11-142-07

Graefe
Size 1,



UE-11-143-07

Graefe
Size 1,



UE-11-144-07

Graefe
Size 1,



UE-11-145-07

Fischer
Size 1,



UE-11-146-07
Barraquer Katzin
Size 1,



UE-11-147-07
Troutman
Size 1,



UE-11-148-07
Barraquer
Size 1,



UE-11-149-07
Barraquer
Size 1,



UE-11-150-09
McCullough
Size 1,



UE-11-151-09
McCullough
Size 1,



UE-11-152-10

Jameson
Size 1,



UE-11-153-10

Jameson
Size 1,



UE-11-154-10

Bonaccolto
Size 1,



UE-11-155-10

Bonaccolto
Size 1,



UE-11-156-10

Dastoor
Size 1,



UE-11-157-10

Dastoor
Size 1,



UE-11-158-05
Bishop Harman
Size 1,



UE-11-159-08
Bishop Harman
Size 1,



UE-11-160-05
Bishop Harman
Size 1,



UE-11-161-08
Bishop Harman
Size 1,



UE-11-162-07
Mod Bonn
Size 1,



UE-11-163-07
Mod Bonn
Size 1,



UE-11-164-10
Mod Bonn
Size 1,



UE-11-165-10
Mod Bonn
Size 1,



UE-11-166-10
Mod Bonn
Size 1,



UE-11-167-10
Mod Bonn
Size 1,



UE-11-168-10
Prince
Size 1,



UE-11-169-10
Prince
Size 1,



UE-11-170-20

Berke
Size 1,



UE-11-171-08

Troutman
Size 1,



UE-11-172-05

Barraquer
Size 1,



UE-11-173-11

Elsching
Size 1,



UE-11-174-11

Graefe
Size 1,



UE-11-175-09

Lester
Size 1,

Ophthalmology



UE-11-176-09
Castroviejo
Size 1,



UE-11-178-09
Castroviejo
Size 1,



UE-11-179-09
Barraquer
Size 1,



UE-11-180-10
Green
Size 1,



UE-11-181-07
Gill Arruga
Size 1,



UE-11-182-01
Castroviejo
Size 1,



UE-11-183-05
Castroviejo
Size 1,



UE-11-184-10
Moorfield
Size 1,



UE-11-185-07
St Martin
Size 1,



UE-11-186-10
Mod Tubingen
Size 1,



UE-11-187-10
McPherson
Size 1,



UE-11-188-10
McPherson
Size 1,

Ophthalmology



UE-11-189-09

Ayer
Size 1,



UE-11-190-09

Ayer
Size 1,



UE-11-191-09

Desmarres
Size 1,



UE-11-192-10

Snellen
Size 1,



UE-11-1193-11

Knapp Luer
Size 1,



UE-11-194-28

Scheie
Size 1,

Ophthalmology



UE-11-195-45
Mod Tubingen
Size 1,



UE-11-196-00
Elliot
Size 1,



UE-11-197-09
Beer
Size 1,



UE-11-198-10
Barraquer



UE-11-199-09
Douglas
Size 1,



UE-11-200-09
Gradle
Size 1,



UE-11-177-09

Castroviejo
Size 1,



UE-11-119-07

Mueller
Size 1,

Tracheotomy

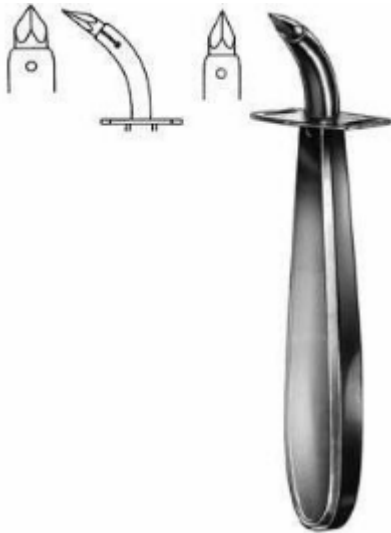

Ueckermann
UE-16-101-13
Tracheotomy Trocar
11.5 cm,



Iterson
UE-16-102-16
Tracheal Hook
17 cm,



Rose
UE-16-103-13
Tracheal Hook
13.5 cm,



Luer
UE-16-104-11
Tracheal Hook
11 cm,



UE-16-105-15
Tracheal Hook
15 cm,



Lukens
UE-16-106-17
Thymus Retractor
17.5 cm,

Tracheotomy



Jackson
UE-16-107-17
Tracheal Hook
18 cm,



Kocher
UE-16-108-15
Goitre Enucleator
16.5 cm,



Kocher
UE-16-109-15
Goitre Enucleator
16.5 cm,



Hofmeister
UE-16-110-21
Goitre Enucleator
20.5 cm,

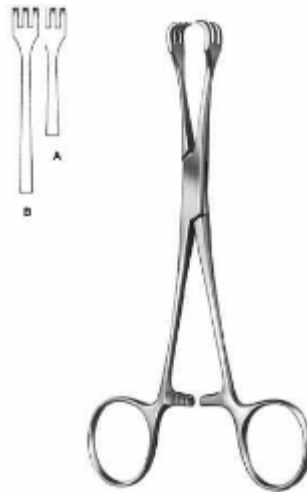

Lahey
UE-16-111-15
Goitre Grasping Forceps
15.5 cm,



Luer
UE-16-112-04
Tracheal Tube



Luer
UE-16-113-08
Tracheal Tube



Chevalier-Jackson
UE-16-114-04
Tracheal Tube outer tube closed inner tube
closed silver



UE-16-115-08
Speaking Tube



Moncorp
UE-17-101-14
Milium Knife
14 cm,



Moncorp
UE-17-102-00
Spare Blade



Vidal
UE-17-103-14
Lupus Scraper
13 cm,



Wolff
UE-17-105-01
Lupus Curette
14 cm,



Kilner
UE-17-106-15
Skin Hooklet
14.5 cm,



Gillies
UE-17-107-18
Skin Hooklet
18 cm,



Kaye

UE-17-108-03

Face-lift Hook
13 cm,

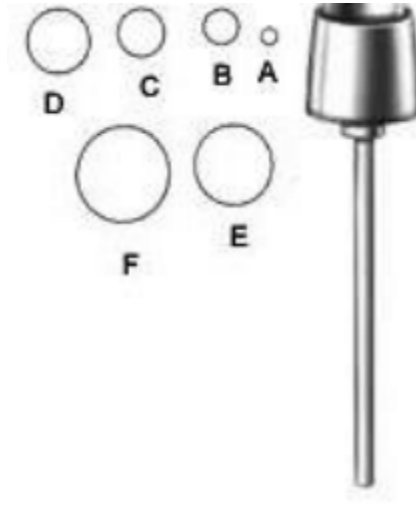

UE-17-109-02

Dermal Punch
5.5 cm,



Handle

UE-17-110-00

8 cm,

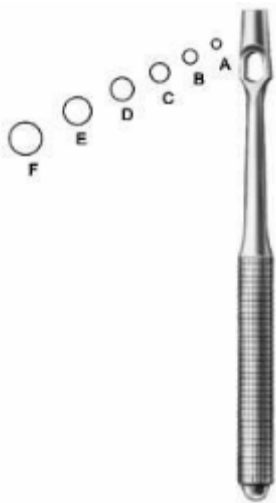

Keyes

UE-17-111-02

Dermal Punch
11 cm,



Unna

UE-17-113-14

Comedone Extractor
14.5 cm,



Saalfeld

UE-17-114-10

Comedone Extractor
11 cm,



Saalfeld

UE-17-115-14

Saalfeld Comedone Extractor
14.5 cm,



Schamberg

UE-17-116-10

Comedone Extractor
9.5 cm,



Katsch

UE-17-117-14

Comedone Extractor
16 cm,



Unna-Vidal

UE-17-118-11

Comedone Extractor
11.5 cm,



d'Assump?

UE-17-119-15

Face-lift Forceps
18 cm,



Gregory

UE-17-120-14

Face-lift Scissors
14 cm,



Kaye

UE-17-121-15

Face-lift Scissors
15 cm, 18 cm,



Stella-S

UE-17-122-18

Face-lift Scissors
18 cm,



Gorney

UE-17-123-18

Face-lift Scissors
18 cm,



Freeman-Kaye

UE-17-124-18

Face-lift Scissors
18 cm,

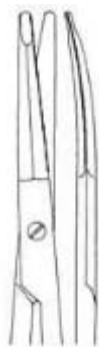

Freeman

UE-17-125-00

Face-lift Scissors
23 cm,



Fox

UE-17-104-01

Lupus Curette
14 cm,



Unna

UE-17-112-14

Comedone Extractor
14.5 cm,

Intestines & Stomach



Allis-Baby

UE-18-101-12

Intestinal and Tissue Grasping Forceps
13 cm,

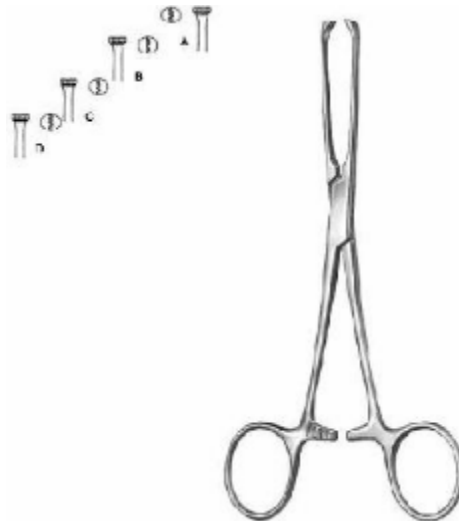

Allis

UE-18-102-15

Intestinal and Tissue Grasping Forceps
15.5 cm, 19 cm, 25.5 cm,

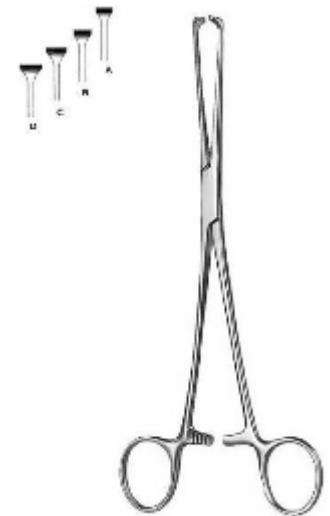

Allis

UE-18-103-16

Intestinal and Tissue Grasping Forceps
15.5 cm, 20 cm, 24.5 cm, 30 cm,



Allis-Adair

UE-18-104-15

Intestinal and Tissue Grasping Forceps
16 cm,



Boys-Allis

UE-18-105-15

Intestinal and Tissue Grasping Forceps
15.5 cm,



Thoms-Allis

UE-18-106-20

Intestinal and Tissue Grasping Forceps
20.5 cm,

Intestines & Stomach



Allis

UE-18-107-20

Intestinal and Tissue Grasping Forceps
20 cm,



Lockwood

UE-18-108-20

Intestinal and Tissue Grasping Forceps
20 cm,



Williams

UE-18-109-16

Intestinal and Tissue Grasping Forceps
16.5 cm,

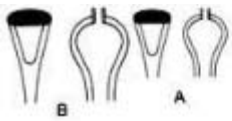

Babcock

UE-18-110-16

Intestinal and Tissue Grasping Forceps
16.5 cm, 21 cm,

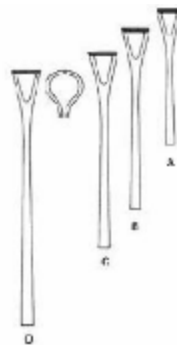

Babcock

UE-18-111-16

Intestinal and Tissue Grasping Forceps
15.5 cm, 17.5 cm, 21 cm, 24 cm,

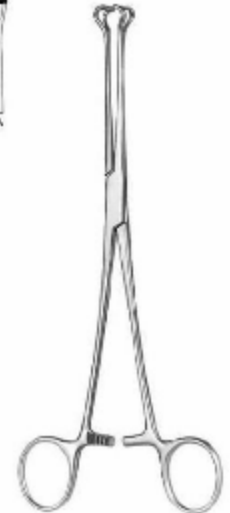

Babcock

UE-18-112-16

Intestinal and Tissue Grasping Forceps
16 cm, 20.5 cm,

Intestines & Stomach



Duval

UE-18-113-20

Intestinal and Tissue Grasping Forceps
20.5 cm,

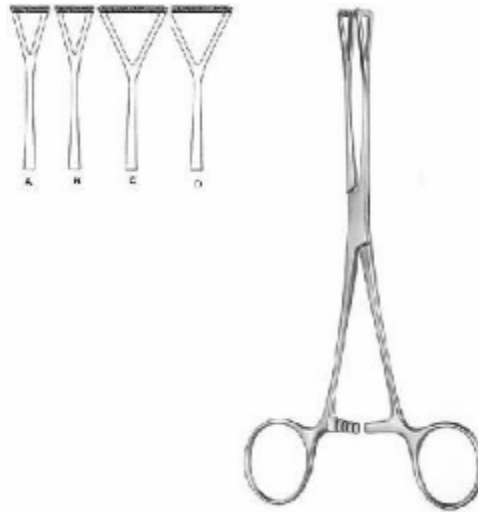

Duval

UE-18-114-18

Intestinal and Tissue Grasping Forceps
18 cm, 20.5 cm, 23 cm,

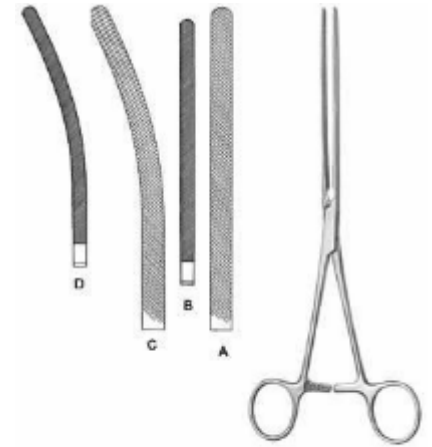

Doyen

UE-18-115-21

Intestinal Clamp
21.5 cm, 23.5 cm,

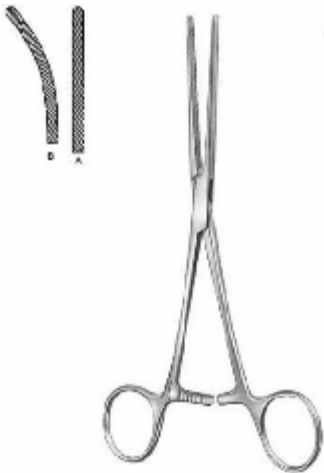

Doyen-Baby

UE-18-116-18

Intestinal Clamp
18 cm, 17.5 cm,



Mayo-Robson

UE-18-117-21

Intestinal Clamp
21.5 cm, 23.5 cm, 23 cm,

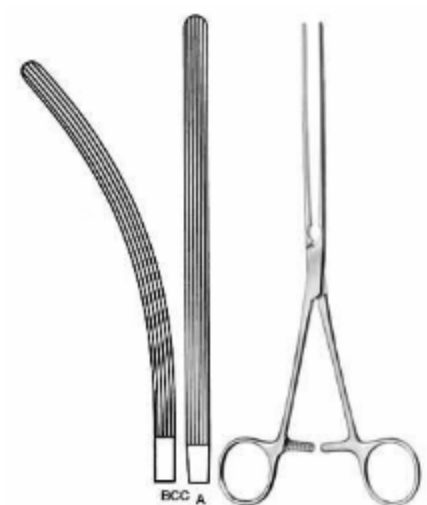

Mayo-Robson

UE-18-118-25

Intestinal Clamp
25.5 cm, 24.5 cm,

Intestines & Stomach

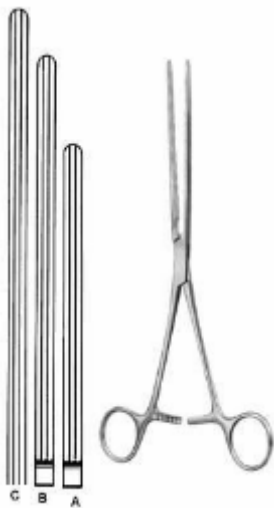

Kocher

UE-18-119-22

Intestinal Clamp
22.5 cm, 25 cm, 28.5 cm,

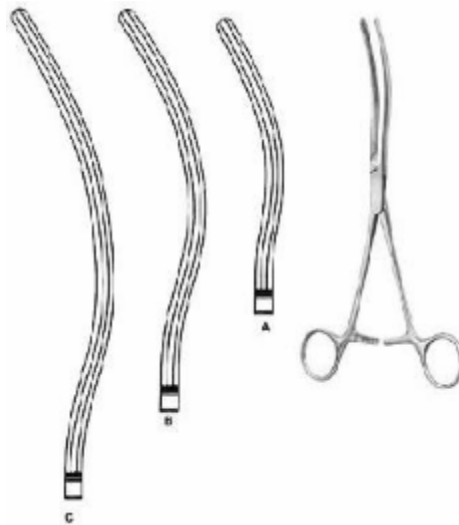

Kocher

UE-18-120-22

Intestinal Clamp
22 cm, 24.5 cm, 27.5 cm,



Allen

UE-18-121-16

Intestinal Clamp
16 cm,



Payr-Baby

UE-18-122-15

Intestinal and Pylorus Clamp
15 cm,

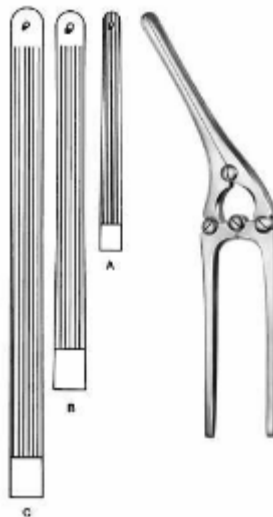

Payr

UE-18-123-21

Intestinal and Pylorus Clamp
20.5 cm, 29 cm, 34.5 cm,



Stone-Watt

UE-18-124-07

Intestinal Anastomosis Clamp
8.5 cm, 10 cm,

Intestines & Stomach



Stone-Watt
UE-18-125-15
Closing Forceps

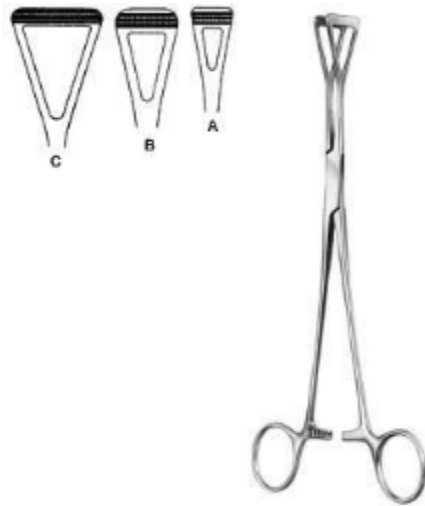

Scheibe
UE-18-126-18
Organ Grasping Forceps
18 cm,



Doyen-Baby
UE-18-127-13
Intestinal Clamp
14 cm, 17 cm,

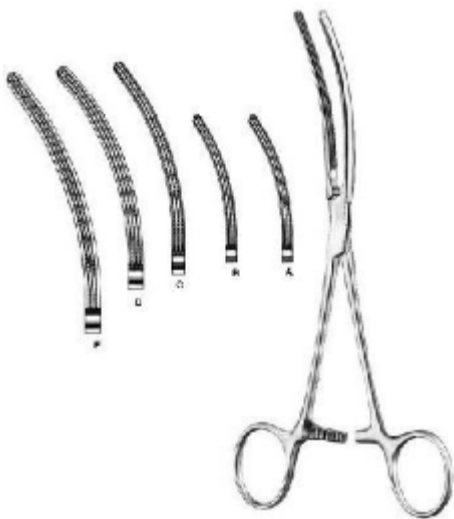

Doyen-Baby
UE-18-128-13
Intestinal Clamp
13.5 cm, 17 cm,



Mayo-Robson
UE-18-129-25
Intestinal Clamp
26 cm,



Mayo-Robson
UE-18-130-25
Intestinal Clamp
25 cm,

Intestines & Stomach



Kocher

UE-18-131-22

Intestinal Clamp
22.5 cm, 28 cm,



Kocher

UE-18-132-22

Intestinal Clamp
22 cm, 25 cm, 27.5 cm,



Scudder

UE-18-133-33

Intestinal Clamp
33.5 cm,

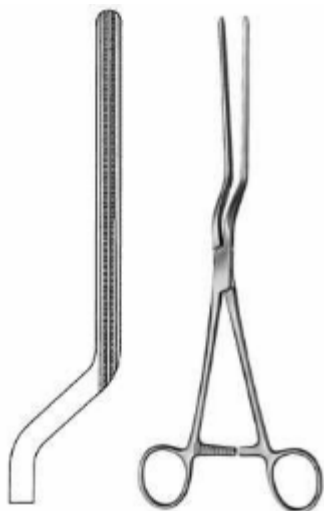

Brunner

UE-18-134-24

Sigmoid Anastomosis Forceps
27 cm,



Hayes

UE-18-135-26

Sigmoid Anastomosis Forceps
27 cm, 28 cm,



Veidenheimer

UE-18-136-23

Sigmoid Anastomosis Forceps
25 cm,

Intestines & Stomach



Fehland

UE-18-137-24

Sigmoid Anastomosis Forceps
24 cm,

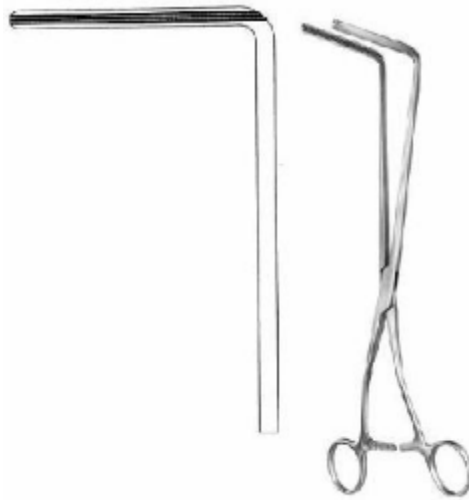

Resano

UE-18-138-30

Sigmoid Anastomosis Forceps
28 cm,



Sims

UE-18-139-15

Rectal Speculum
15.5 cm,



Sims

UE-18-140-15

Rectal Speculum
15.5 cm,



Mathieu

UE-18-141-19

Rectal Speculum
19 cm,



Alan-Parks

UE-18-142-00

Alan-Parks
14 cm,

Intestines & Stomach



McGinvey

UE-18-143-19

Hemorrhoidal Grasping Forceps
19 cm,



UE-18-144-00

Handle for biopsy forceps



UE-18-145-38

Rectal Biopsy Forceps

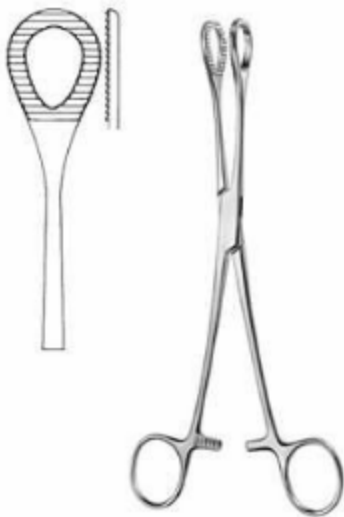

Heywood-Smith

UE-18-146-21

Polypus Grasping Forceps
21 cm,

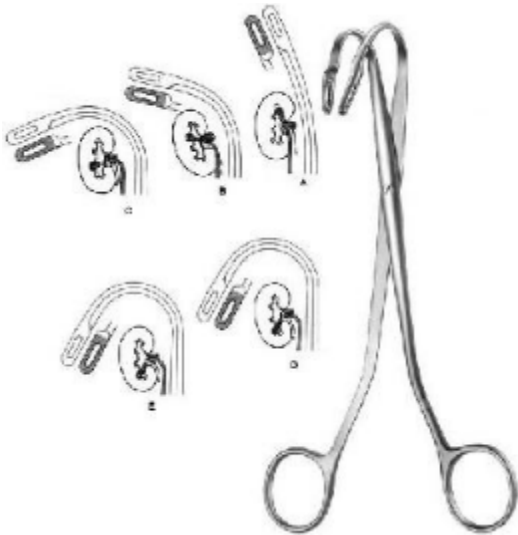

Randall

UE-19-101-23 A

Kidney Stone Forceps
23 cm Fig. 1, 21 cm Fig. 2, 19 cm Fig. 3,



Randall

UE-19-102-23 A

Kidney Stone Forceps
23 cm, 24.5 cm,

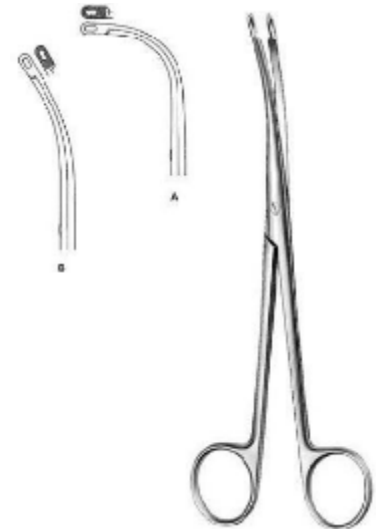

Heiming

UE-19-103-16 A

Kidney Stone Forceps
16 cm Fig. 1, 17 cm Fig. 2,



Elsasser

UE-19-104-01 A

Nephrostomy Forceps
21 cm Fig. 1, 21 cm Fig. 2,



Bakes

UE-19-105-01 A

Gall Duct Dilator
32 cm,

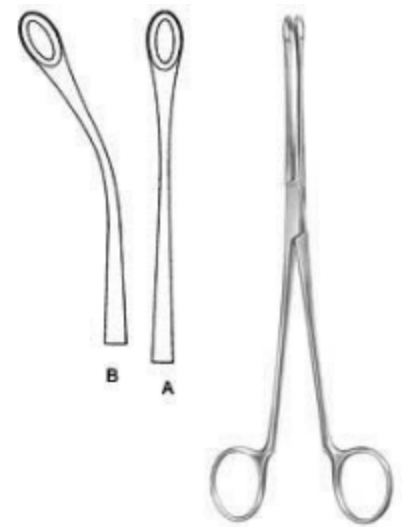

Blake

UE-19-106-20 A

Gall Stone Forceps
21 cm,



Mayo-Blake

UE-19-107-20

Gall Stone Forceps
21 cm,



Mayo-Blake

UE-19-108-20

Gall Stone Forceps
21 cm,



Mixer

UE-19-109-22

Gall Stone Forceps
21.5 cm,



Desjardins

UE-19-110-23 A

Gall Stone Forceps
23 cm,

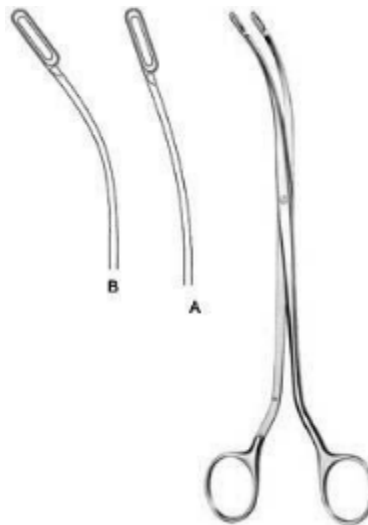

Desjardins

UE-19-111-24 A

Gall Stone Forceps



Luer-Korte

UE-19-112-01 A

Gall Stone Scoop
32 cm Fig. 0,32 cm Fig. 00,32 cm Fig.
000,32 cm Fig. 1,32 cm Fig. 2,32 cm Fig.
3,32 cm Fig. 4,

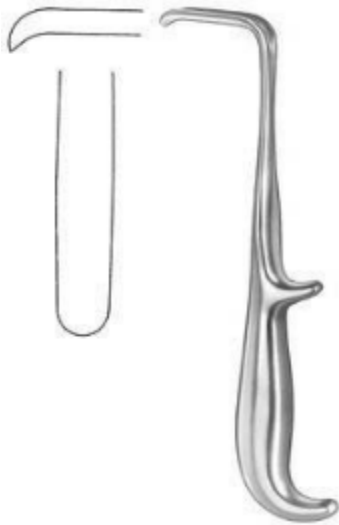

Young

UE-19-113-21

Prostatic Retractor
21.5 cm,



Young

UE-19-114-22

Prostatic Retractor
20.5 cm,



Young

UE-19-115-21

Prostatic Retractor
22 cm,

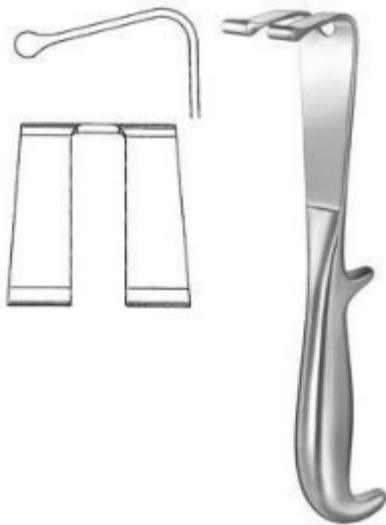

Young

UE-19-116-22

Prostatic Retractor
21.5 cm,



Millin

UE-19-117-24

Capsule Forceps
24.5 cm,



Millin

UE-19-118-24

Capsule Forceps
22 cm,



Millin

UE-19-119-23

Capsule Forceps
24.5 cm,

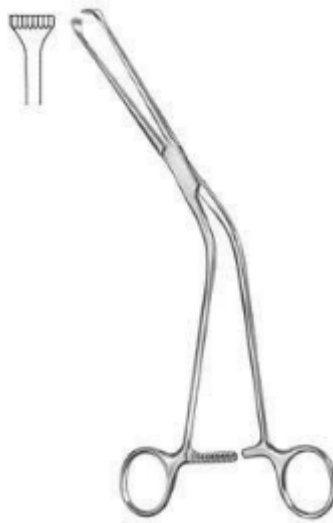

Millin

UE-19-120-23

Capsule Forceps
22 cm,

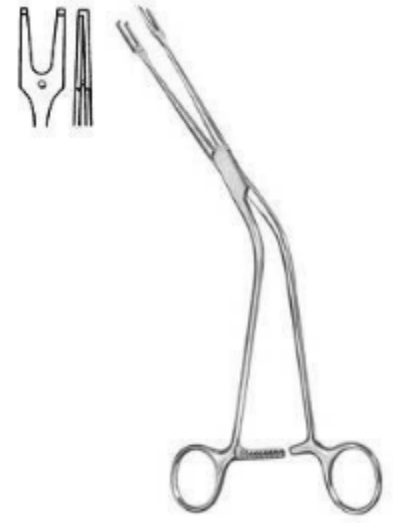

Millin

UE-19-121-24

Ligature Carrying Forceps
24.5 cm,



Millin

UE-19-122-00

Bladder Neck Spreader
29,



Thomson-Walker

UE-19-123-00

Bladder Retractor



Judd-Masson

UE-19-124-00

Bladder Retractor



Millin

UE-19-125-00 A
Bladder Retractor



Legueu

UE-19-126-27
Bladder Spatula
24 cm 35 mm,

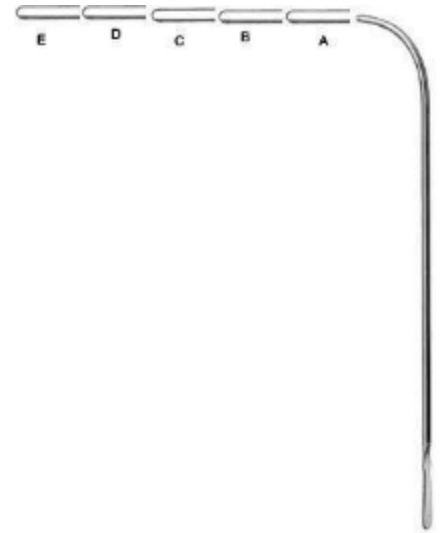

Van Buren

UE-19-127-00 A
Urethral Sound
27.5 cm,



Guyon

UE-19-128-10 A
Urethral Sound
26 cm,



Cusco

UE-20-101

Vaginal Speculum
75 x 32 mm, 85 x 35 mm,



Cusco

UE-20-102-01

Vaginal Speculum
75 x 18 mm,



Cusco

UE-20-103-01

Vaginal Speculum
80 x 22 mm, 100 x 25 mm, 105 x 27 mm,



Cusco

UE-20-104-01

Vaginal Speculum
75 x 34 mm, 85 x 37 mm,



Collin

UE-20-105-01

Vaginal Speculum
85 x 30 mm, 100 x 35 mm,



Pederson

UE-20-106-01

Vaginal Speculum
75 x 13 mm, 100 x 22 mm,



Grave

UE-20-107-01

Vaginal Speculum
75 x 20 mm, 95 x 35 mm,



Semm

UE-20-108-01

Vaginal Speculum
100 x 20 mm, 105 x 27 mm,



Sims

UE-20-109-01

Vaginal Speculum
65 x 25 mm, 70 x 30 mm,



Kristeller

UE-20-110-01

Vaginal Speculum
70 x 27 mm,



Kristeller

UE-20-111-01

Vaginal Retractor
75 x 23 mm,



Kristeller

UE-20-112-01

Vaginal Speculum
Size 1,



Kristeller
UE-20-113-01
Vaginal Speculum
105 x 18 mm,



Kristeller
UE-20-114-01
Vaginal Retractor
110 x 14 mm,



Kristeller
UE-20-115-01
Vaginal Speculum
Size 1,

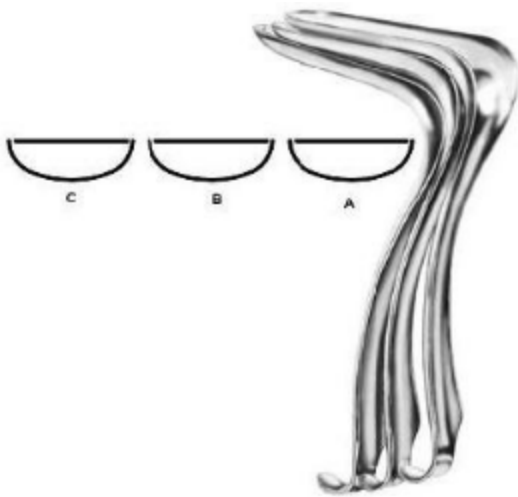

Kristeller
UE-20-116-01
Vaginal Speculum
105 x 26 mm,

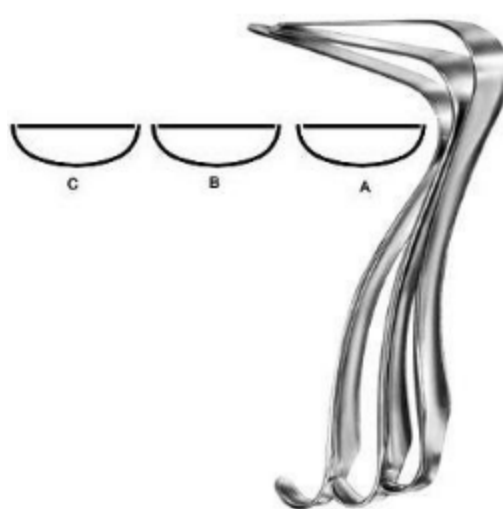

Kristeller
UE-20-117-01
Vaginal Retractor
115 x 22 mm, 115 x 24 mm,



Kristeller
UE-20-118-01
Vaginal Speculum
Size 1,

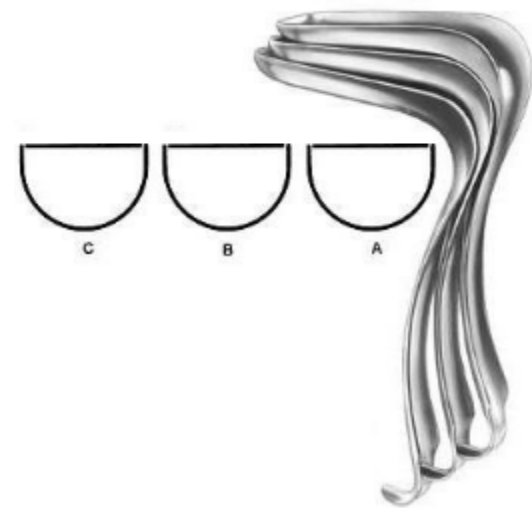

Kristeller
UE-20-119-01
Vaginal Speculum
110 x 27 mm,

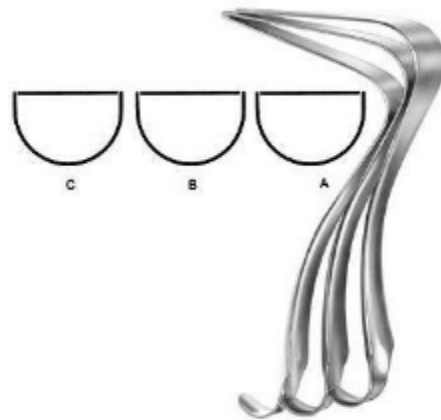

Kristeller
UE-20-120-01
Vaginal Retractor
115 x 23 mm,



Kallmorgen
UE-20-121-01
Vaginal Speculum



Kallmorgen
UE-20-122-01
Vaginal Retractor
70 x 40 mm Fig. 1, 90 x 40 mm Fig. 2,



Kallmorgen
UE-20-123-01
Vaginal Speculum
70 x 33 mm, 90 x 33 mm,

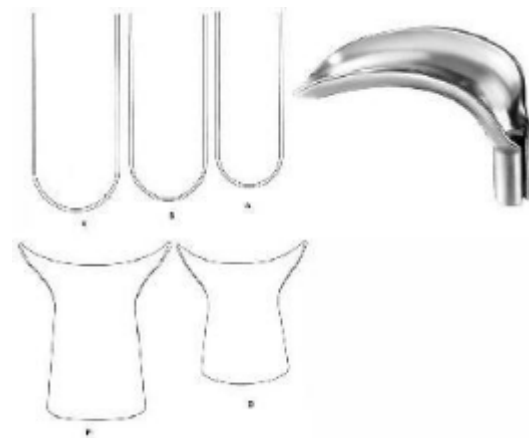

Scherbak
UE-20-125-00
Vaginal Speculum
Size 1,



Auvard

UE-20-126-22

Vaginal Speculum
80 x 43 mm,



Weissbarth

UE-20-127-24

Vaginal Speculum
21 cm 80 x 42 mm,



Breisky

UE-20-128-20

Vaginal Speculum
29 cm 100 x 20 mm, 29 cm 100 x 25 mm,



Kogan

UE-20-129-24

Endocervical Speculum
25 cm 70 x 30 mm,



Kogan

UE-20-130-24

Endocervical Speculum
24.5 cm,



Hegar

UE-20-131-24

Uterine Dilator
18.5 cm 1,0,



Hegar

UE-20-132-02

Uterine Dilator
20 cm 1,0,



Hank

UE-20-133-10

Uterine Dilator
26.5 cm Fig. 9/10,



Sims

UE-20-134-32

Uterine Sound
33 cm,



Valleix

UE-20-135-25

Uterine Sound
29.5 cm,



Braun

UE-20-136-26

Uterine Depressor
27.5 cm,



Schroder

UE-20-137-25

Uterine Tenaculum Forceps
25.5 cm,



Braun

UE-20-138-25

Uterine Tenaculum Forceps
26 cm,



Duplay

UE-20-139-28

Uterine Tenaculum Forceps
25.5 cm,



Beacham

UE-20-140-26

Amniotome
26 cm,



Skene

UE-20-141-24

Uterine Tenaculum Forceps
24 cm,

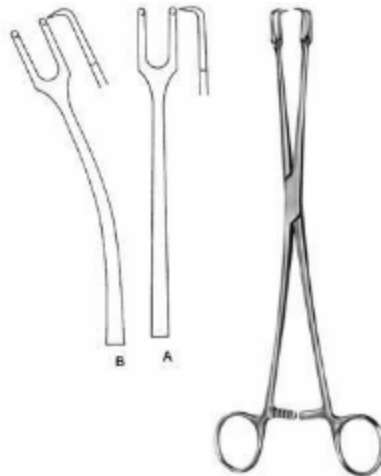

Schroder

IN-20-142-24

Uterine Tenaculum Forceps
25 cm,



Teale

UE-20-143-23

Uterine Tenaculum Forceps
23.5 cm,

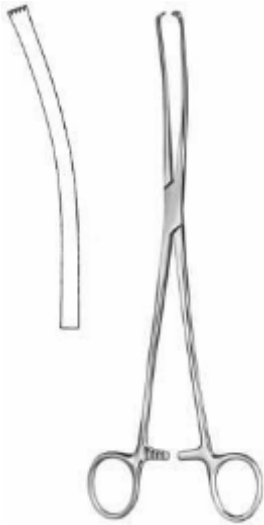

Iowa

UE-20-144-26

Uterine Tenaculum Forceps
26 cm,



Museux

UE-20-145-24

Uterine Tenaculum Forceps
24 cm,



Jacobs

UE-20-146-21

Uterine Tenaculum Forceps
21 cm,

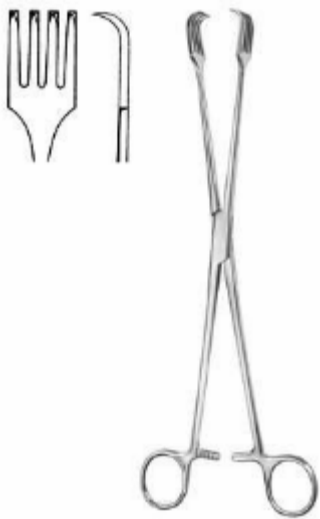

UE-20-147-26

Uterine Tenaculum Forceps
26.5 cm,



Braun

UE-20-148-16

Uterine Tenaculum Forceps
16 cm,

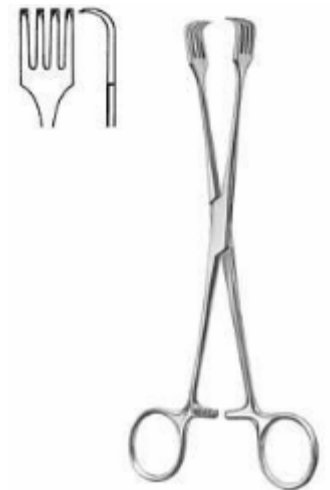

Czerny

UE-20-149-21

Uterine Tenaculum Forceps
21 cm,



Kelly

UE-20-150-32

Uterine Polypus Forceps
32 cm,



Noto

UE-20-151-27

Uterine Polypus Forceps
27 cm,

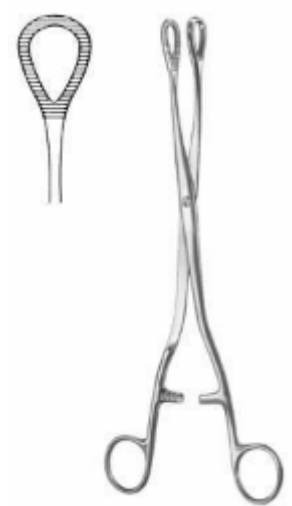

Heywood-Smith

UE-20-152-25

Uterine Polypus Forceps
25 cm,



Doyen

UE-20-153-17

Myoma Screw
17 cm,



Doyen

UE-20-154-17

Myoma Screw
14.5 cm,



Segond

UE-20-155-27

Myoma Knife
28 cm,



Dartigues

UE-20-156-27

Uterine Seizing Forceps
28 cm,



Somer

UE-20-157-27

Uterine Seizing Forceps
22.5 cm,



Collin

UE-20-158-25

Uterine Seizing Forceps jaw 40 mm wide
26 cm,



Ayre

UE-20-159-23

Conization Knife cutting edge 3,6 mm wide
23.5 cm,



Emmett

UE-20-160-03

Fistula Hook
22 cm Fig.3,



Simon

UE-20-161-22

Fistula Hook
21.5 cm,



Simon
UE-20-162-22
Fistula Hook
21.5 cm,



Novak
UE-20-163-23
Suction Curette 4 mm ?
24.5 cm,



Kevorkian
UE-20-164-23
Uterine Biopsy Curette 6,0 mm ?
30 cm,



Munchen
UE-20-165-27
Uterine Biopsy Curette 4,8 mm ?
27 cm,



Gellhorn
UE-20-166-23
Uterine Biopsy Forceps jaw 8,6 mm wide
24 cm,



Faure
UE-20-167-21
Faure Uterine Biopsy Forceps
21 cm,



Schubert

UE-20-168-21

Uterine Biopsy Forceps jaw 4,8 mm wide
21.5 cm, 28 cm,

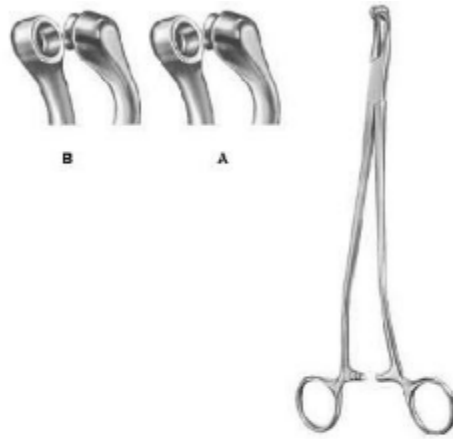

Thoms-Gaylor

UE-20-169-22

Uterine Biopsy Forceps jaw 5,6 mm ?
21 cm, 23.5 cm,

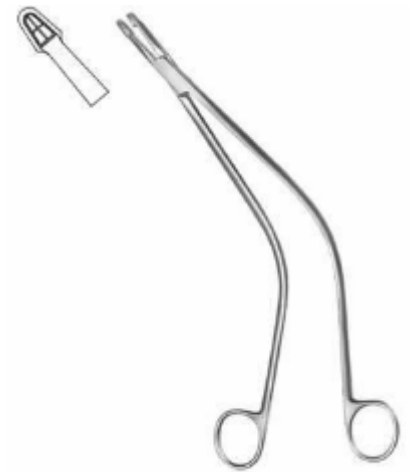

Schubert

UE-20-170-26

Schubert Uterine Biopsy Forceps
25.5 cm,

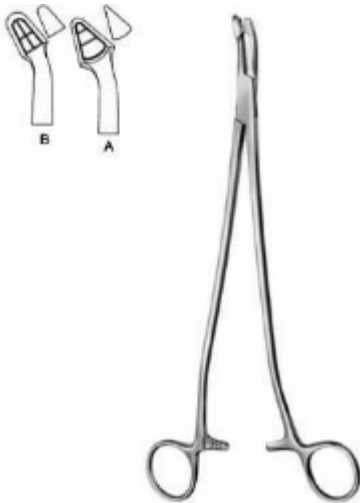

Van Doren

UE-20-171-24

Uterine Biopsy Forceps jaw 4,9 mm wide
27 cm, 25.5 cm,



Alexander

UE-20-172-28

Uterine Biopsy Forceps jaw 5,1 mm wide
28 cm,



Kevorkian

UE-20-173-32

Uterine Biopsy Forceps
25 cm,

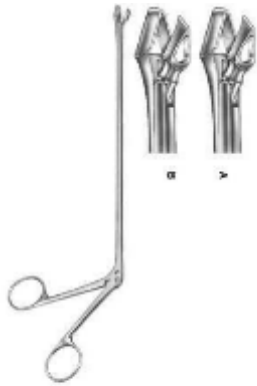

Schumacher
UE-20-174-01

Uterine Biopsy Forceps jaw 4,6 / 5,4 mm wide
24 cm,



Schumacher
UE-20-175-00

Uterine Biopsy Forceps
25 cm,



UE-20-176-22

IUP Grasping Forceps 3 mm ?
22 cm,

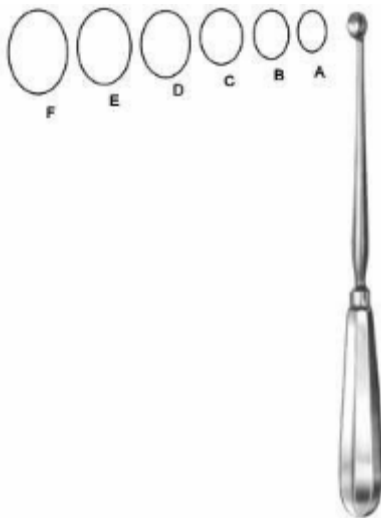

Simon

UE-20-177-01

Uterine Scoop

24.5 cm 9,8 x 8,6 mm, 24.5 cm 11,6 x 8,3 mm,



Simon

UE-20-178-01

Uterine Scoop

30 cm 9,8 x 8,6 mm, 30 cm 11,6 x 8,3 mm,



Recamier

UE-20-179-05

Uterine Curette

31 cm Fig. 00 5 mm, 31 cm Fig. 0 6 mm,



Recamier

UE-20-180-05

Uterine Curette

31 cm Fig. 00 5 mm, 31 cm Fig. 0 6 mm,



Sims

UE-20-181-05

Uterine Curette

31 cm Fig. 00 5 mm, 31 cm Fig. 0 6 mm,



Sims

UE-20-182-05

Uterine Curette

31 cm Fig. 00 5 mm, 31 cm Fig. 0 6 mm,



UE-20-183-03

Suction Curette

29 cm 3,0 mm ?, 29 cm 4,5 mm ?, 29 cm 6,0 mm ?,



Martin

UE-21-101-34

Pelvimeter cm, inch scale
34 cm,



Nagele

UE-5-102-36

Obstetrical Forceps
35 cm, 40.5 cm,



Simpson

UE-5-103-30

Obstetrical Forceps
31 cm,



Wrigley

UE-5-104-28

Obstetrical Forceps
28 cm,



Simpson

UE-21-105-36

Obstetrical Forceps
36.5 cm,



Kielland

UE-21-106-41

Obstetrical Forceps
42 cm,

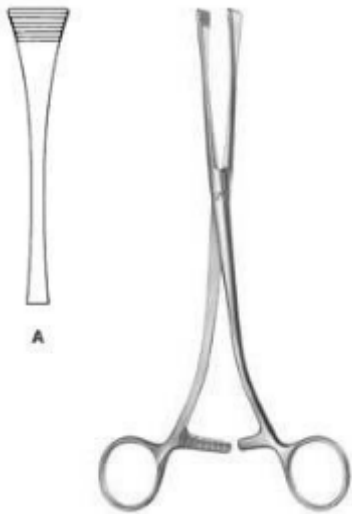

Green-Armytage
UE-21-107-21
Uterine Clamp
21 cm,



Sellheim
UE-21-108-28
Obstetrical Lever
32 cm,

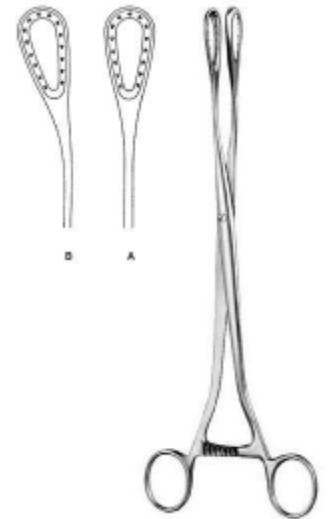

Sanger
UE-21-109-27
Placenta and Ovum Forceps
27.5 cm, 27 cm,

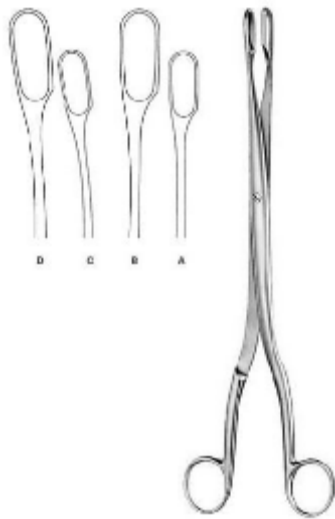

Winter
UE-21-110-01
Placenta and Ovum Forceps
28 cm Fig. 1, 28 cm Fig. 2,

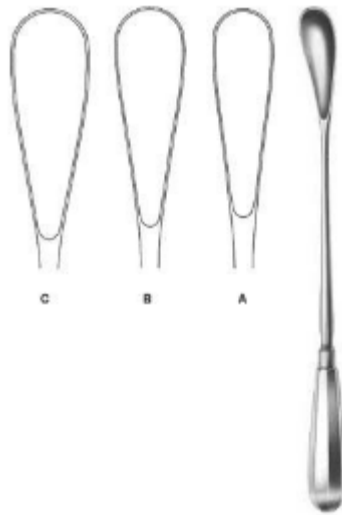

Cuzzi
UE-21-111-01
Placenta Scoop
30 cm 14,5 mm, 30 cm 18 mm,



Pestaloza
UE-21-112-30
Placenta Scoop
30 cm,



Kane

UE-21-113-08

Umbilical Cord Clamp
8.5 cm,



Collin

UE-21-114-09

Umbilical Cord Clamp
8.5 cm,



Irrigator
UE-23-101-10
Size 1,



Round Bowl
UE-23-102-16
220 mm x 70 mm, 400 mm x 150 mm,



UE-23-103-33
Round Bowl
? x h 6,00 l,



Flat Dish
UE-23-104-11
? x h 0,20 l,



Lid only
UE-23-105-11
Size 1,



Stainless Steel
UE-23-106-04
? x h 0,30 l,



Round Dish

UE-23-107-11

? x h 0,30 l, ? 128 x 38 mm 0,40 l,



Flat Dish

UE-23-108-11

? x h 0,15 l,



Measurer

UE-23-109-01

graduated inside
100cc = 0,1 l,



Measurer

UE-23-110-02

Graduated Inside
0,25 l, 0,50 l,



Petri Dish

UE-23-111-10

with Lid ? x h



Petri Dish

UE-23-112-09

without lid ? x h
Size 1,



Lid for Petri Dishes
UE-23-113-10
Size 1,



Universal Tray
UE-23-114-23
l x b x h,



Instrument Tray
UE-23-115-21
l x b x h,



Universal Tray
UE-23-116-23
l x b x h,



Round Bowl
UE-23-117-22
? x h,



Metal Jar
UE-23-118-30
? 30mm x 90 mm, ? 50mm x 100 mm,



Instrument Box
UE-23-119-16
lid with knob
l x b x h,



Instrument Box
UE-23-120-16
lid with knob
l x b x h,



Instrument Box
UE-23-121-20
l x b x h,



Round Metal Box
UE-23-122-06
? 75 mm x 75 mm, ? 100 mm x 60 mm,



Medicine Cup Graduated Inside
UE-23-123-25
25 ccm,



Medicine Cup Graduated Inside
UE-23-124-50
50 ccm,



Tablet Tray

UE-23-125-75

? 75 mm x 12 mm,



Metal Cup

UE-23-126-90

? 90 mm x 90 mm,



Denture Cup

UE-23-127-75

? 75 mm x 50 mm,



Insert for Cup

UE-23-128-75

? 73 mm x 75 mm,



Kidney Dish

UE-23-129-17

l x b x h,



Placenta Pan

UE-23-130-36

Size 1,



Waste Cotton Collector

UE-23-131-01

? 50 mm x 75 mm,



Spirit Lamp

UE-23-132-07

120 ccm,



Charrière
UE-7-102-35
Amputation Saw
35 cm,



Langenbeck
UE-7-103-23
Amputation Saw
24.5 cm,



Charrière
UE-7-104-27
Amputation Saw
26.5 cm,



UE-7-105-14
Reamer
13.5 cm,



Perthes
UE-7-106-18
Reamer
18 cm,



Perthes
UE-7-107-21
Reamer
21.5 cm,

Bone Surgery



UE-7-108-14

Reamer
14 cm,



UE-7-111-18

Flat Trepine

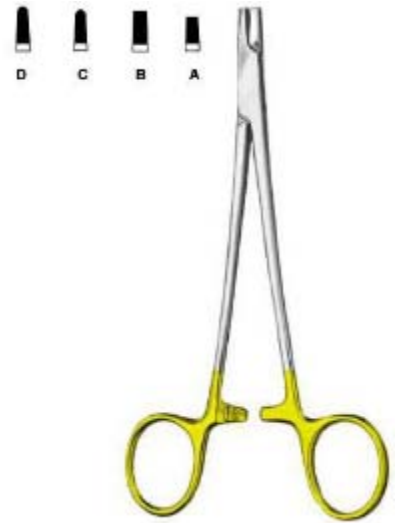

UE-7-112-01

Wire Twisting Forceps
15.5 cm, 18 cm, 20 cm,



UE-7-113-15

Wire Twisting Forceps
15.5 cm,



UE-7-114-17

Flat Nose Plier
18.5 cm,



UE-7-115-18

Wire Twisting Forceps
19 cm,

Bone Surgery



UE-7-116-15
Combi-Flat Nose Plier
15 cm,



UE-7-117-01
Flat Nose Plier
18 cm,

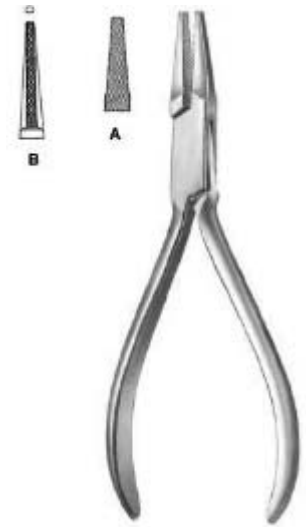

UE-7-118-14
Flat Nose Plier
13.5 cm,



Hackstock
UE-7-119-16
Flat Nose Plier
16 cm,



UE-7-120-01
Flat Nose Plier
17.5 cm,



UE-7-121-18
Wire Cutting Pliers
18.5 cm,

Bone Surgery



UE-7-122-15
Wire Cutting Pliers
15 cm,



UE-7-123-18
Wire Cutting Pliers
17.5 cm,



Demel
UE-7-124-18
Wire Guide
31 cm Fig. 1, 29 cm Fig. 2, 28 cm Fig. 3,

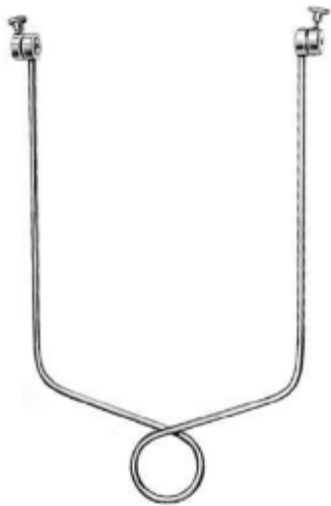

Bohler
UE-7-125-15
Extension Bow



Kirschner
UE-7-126-01
Extension Bow
18.5 cm, 26.5 cm,



UE-7-127-06
Traction Hook for Extension Bows



Kirschner
UE-7-128-06
Wire Drill
6 cm, 12 cm,



Kirschner
UE-7-129-06
Wire Drill
14 cm, 16 cm,



Kirschner
UE-7-130-10
Wire Drill
31 cm,



Kirschner
UE-7-131-10
Wire Drill
6 cm, 12 cm, 18 cm,



Kirschner
UE-7-132-10
Wire Drill
31 cm,



Buckley
UE-7-133-02
Chisel
16 cm,

Bone Surgery



Buckley
UE-7-134-02
Gouge
16 cm,



Stout
UE-7-135-03
Bone Chisel
21 cm,



UE-7-136-04
Bone Chisel
18 cm,



UE-7-137-04
Bone Chisel
18 cm,



UE-7-138-04
Bone Chisel
17 cm,



UE-7-139-04
Bone Chisel
17 cm,

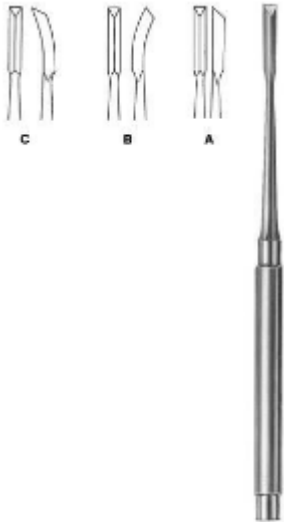

Gardner
UE-7-140-01
Bone Chisel
17 cm 4mm,



Snyder-O.S.U.
UE-7-141-03
Bone Chisel
16.5 cm 3mm, 16.5 cm 5.5mm,



O.S.U.
UE-7-142-01
one Chisel
17 cm 7mm,



O.S.U.
UE-7-143-01
one Chisel
17 cm 9mm,



UE-7-144-08
Osteotome
13.5 cm 8mm, 13.5 cm 10mm, 13.5 cm
12mm, 13.5 cm 14mm, 13.5 cm 16mm,



UE-7-145-08
Chisel
13.5 cm 8mm, 13.5 cm 10mm, 13.5 cm
12mm, 13.5 cm 14mm, 13.5 cm 16mm,



UE-7-146-08

Gouge

13.5 cm 8mm, 13.5 cm 10mm, 13.5 cm 12mm, 13.5 cm 14mm, 13.5 cm 16mm,



Partsch

UE-7-147-02

Chisel

13.5 cm 2mm, 13.5 cm 3mm, 13.5 cm 4mm, 13.5 cm 5mm, 13.5 cm 6mm, 17 cm 2mm, 17 cm 3mm, 17 cm 4mm, 17 cm 5mm, 17 cm 6mm,



Partsch

UE-7-148-02

Gouge

13.5 cm 2mm, 13.5 cm 3mm, 17 cm 2mm, 17 cm 3mm,



Stille

UE-7-149-10

Chisel

20 cm 10mm, 20 cm 15mm, 20 cm 20mm, 20 cm 25mm,



Stille

UE-7-150-10

Osteotome

20 cm 10mm, 20 cm 15mm, 20 cm 20mm, 20 cm 25mm,



Stille

UE-7-151-10

Gouges

20 cm 10mm, 20 cm 15mm, 20 cm 20mm, 20 cm 25mm,



Lambotte, Mini
UE-7-152-02

Osteotome
12.5 cm 2mm, 12.5 cm 3mm, 12.5 cm
4mm, 12.5 cm 6mm, 12.5 cm 8mm,



Lambotte
UE-7-153-15

Osteotome
24 cm 15mm, 24 cm 20mm, 24 cm 25mm, 24
cm 30mm,



Lambotte
UE-7-154-15

Osteotome
24 cm 15mm, 24 cm 20mm, 24 cm 25mm, 24
cm 30mm,



Smith-Petersen
UE-7-155-06

Osteotome
20.5 cm 6mm, 20.5 cm 9mm, 20.5 cm 13mm,



Smith-Petersen
UE-7-156-06

Osteotome
20.5 cm 6mm, 20.5 cm 9mm, 20.5 cm
13mm, 20.5 cm 16mm, 20.5 cm 19mm,



Smith-Petersen
UE-7-157-09

Gouge
20.5 cm 9mm, 20.5 cm 14mm, 20.5 cm
19mm, 20.5 cm 25mm,



Smith-Petersen

UE-7-158-09

Gouge

20.5 cm 9mm, 20.5 cm 14mm, 20.5 cm 19mm,



Hoke

UE-7-159-03

Osteotome

17 cm 3mm, 17 cm 5mm, 17 cm 6mm, 17 cm 8mm,

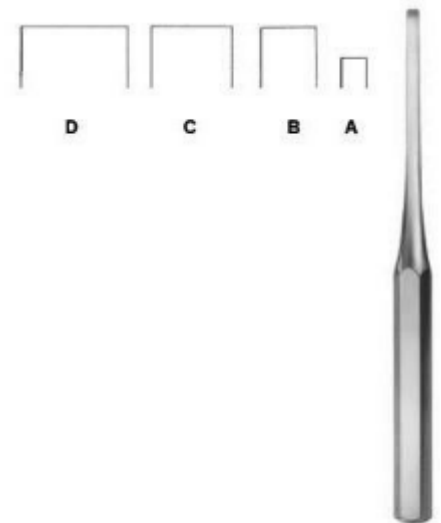

Hibbs

UE-7-160-06

Osteotome

24.5 cm 6mm, 24.5 cm 13mm, 24.5 cm 19mm,

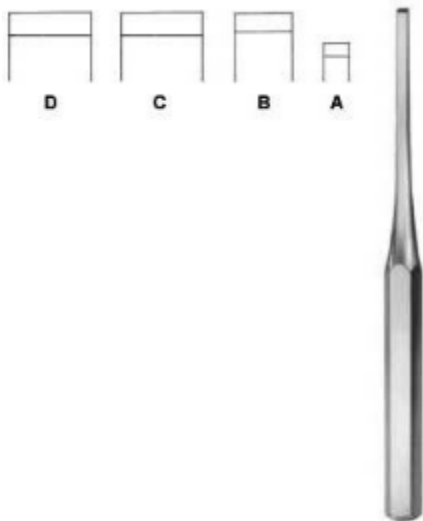

Hibbs

UE-7-161-06

Chisel

24.5 cm 6mm, 24.5 cm 19mm, 24.5 cm 13mm,

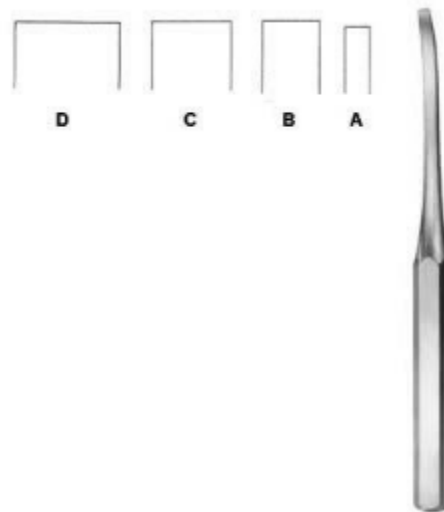

Hibbs

UE-7-162-06

Osteotome

24.5 cm 6mm, 24.5 cm 13mm, 24.5 cm 19mm,

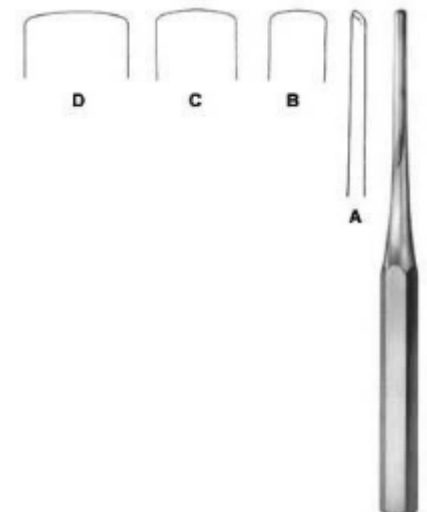

Hibbs

UE-7-163-06

Hibbs

24.5 cm 6mm, 24.5 cm 13mm, 24.5 cm 19mm,

Bone Surgery



Hibbs

UE-7-164-06

Gouge

24.5 cm 6mm, 24.5 cm 13mm, 24.5 cm 19mm,

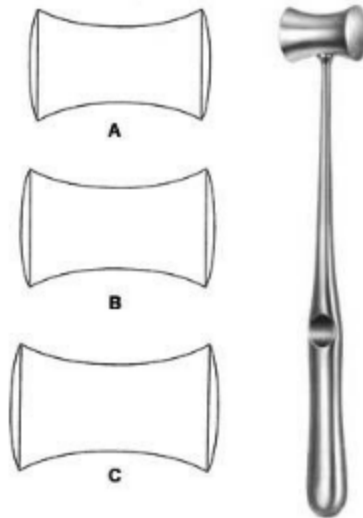

Williger

UE-7-165-01

Mallet

24 cm,

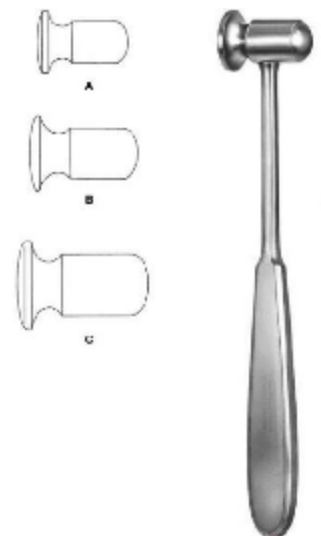

Doyen

UE-7-166-01

Mallet

20.5 cm, 21 cm, 21.5 cm,



Collin

UE-7-167-20

Mallet

20 cm,

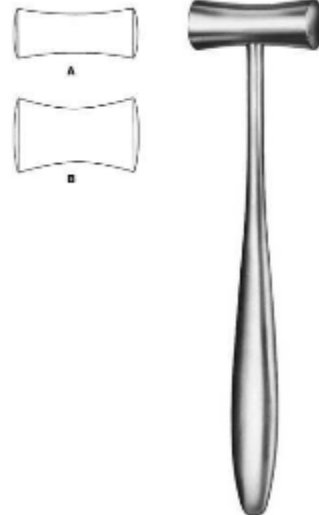

Lucae

UE-7-168-01

Mallet

19.5 cm,



Cottle

UE-7-169-19

Mallet

19 cm,

Bone Surgery



Williger
UE-7-170-01
Mallet
16.5 cm,



Mead
UE-7-171-17
Mallet
19 cm,



Partsch
UE-7-172-18
Mallet
19 cm,



Schede
UE-7-173-01
Bone Curette Fig. 0 to 4
17 cm,



Volkman
UE-7-174-01
Bone Curette
17 cm Fig. 0, 17 cm Fig. 00, 17 cm Fig. 000, 17 cm Fig. 1, 17 cm Fig. 2, 17 cm Fig. 3, 17 cm Fig. 4,



Bruns
UE-7-175-01
Bone Curette
17 cm Fig. 0, 17 cm Fig. 00, 17 cm Fig. 000, 17 cm Fig. 1, 17 cm Fig. 2, 17 cm Fig. 3, 17 cm Fig. 4,



Spratt

UE-7-176-01

Bone Curette

17 cm Fig. 0, 17 cm Fig. 00, 17 cm Fig. 000, 17 cm Fig. 0000, 17 cm Fig. 1, 17 cm Fig. 2, 17 cm Fig. 3, 17 cm Fig. 4, 17 cm Fig. 5,

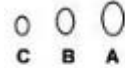

Bruns

UE-7-177-01

Bone Curette

23 cm Fig. 0, 23 cm Fig. 00, 23 cm Fig. 000, 23 cm Fig. 1, 23 cm Fig. 2, 23 cm Fig. 3,

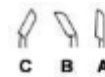

Scoville

UE-7-178-25

Bone Curette
25 cm,

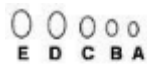

Simon

UE-7-179-01

Bone Curette

25 cm Fig. 1, 25 cm Fig. 2, 25 cm Fig. 3, 25 cm Fig. 4, 25 cm Fig. 5,

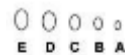

Modell USA

UE-7-180-01

Bone Curette

16 cm Fig. 1, 16 cm Fig. 2, 16 cm Fig. 3, 16 cm Fig. 4,

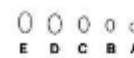

Modell USA

UE-7-181-01

Bone Curette

15.5 cm Fig. 1, 15.5 cm Fig. 2, 15.5 cm Fig. 3, 15.5 cm Fig. 4,



Modell USA
UE-7-182-01

Bone Curette

15.5 cm Fig. 1, 15.5 cm Fig. 2, 15.5 cm Fig. 3, 15.5 cm Fig. 4,



Halle

UE-7-183-01

Bone Curette

21 cm Fig. 1, 21 cm Fig. 2, 21 cm Fig. 3,



Volkmann

UE-7-184-01

Bone Curette, double-ended
12.5 cm, 14.5 cm, 17 cm,



Volkmann

UE-7-185-13

Bone Curette, double-ended
13 cm, 16 cm,



UE-7-186-21

Bone Curette, double-ended
21 cm,



Williger

UE-7-187-00

Bone Curette, double-ended
13.5 cm Fig. 00/0, 13.5 cm Fig. 0/1, 13.5 cm Fig. 1/2,

Bone Surgery



Hemingway
UE-7-189-11

Bone Curette, double-ended
18 cm,



Hemingway
UE-7-190-00

Bone Curette, double-ended
18.5 cm,



UE-7-191-01

Bone Curette, double-ended
17.5 cm,

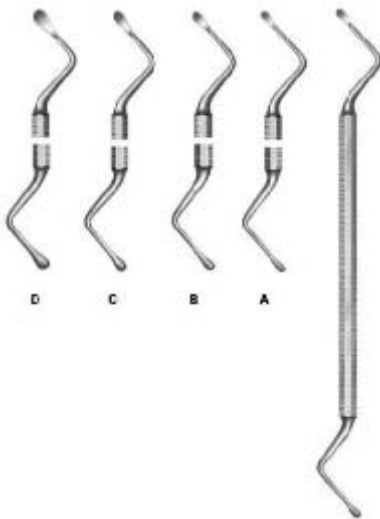

Lucas

UE-7-192-11

Bone Curette, double-ended
18 cm,

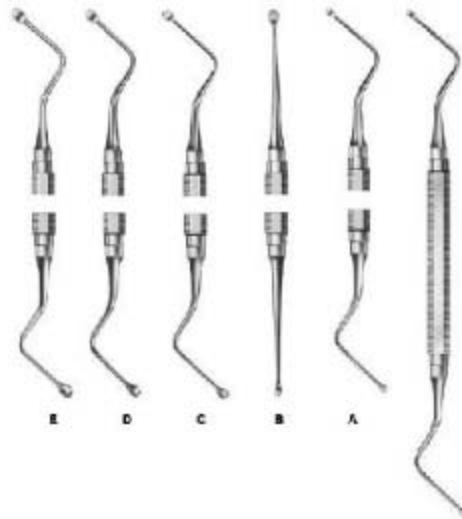

Miller-Colburn

UE-7-193-00

Bone Curette, double-ended
17 cm Fig. 0, 17 cm Fig. 1, 17 cm Fig. 2, 17 cm Fig. 3,

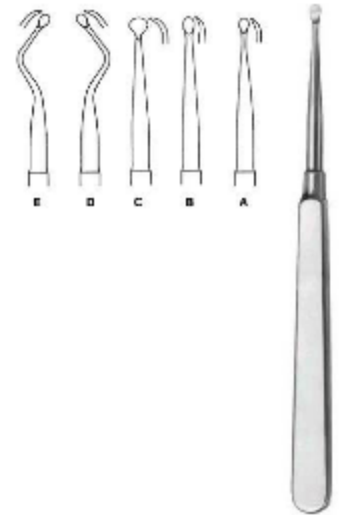

Molt

UE-7-194-01

Bone Curette
17 cm Fig. 1, 17 cm Fig. 2, 17 cm Fig. 3, 17 cm Fig. 4,

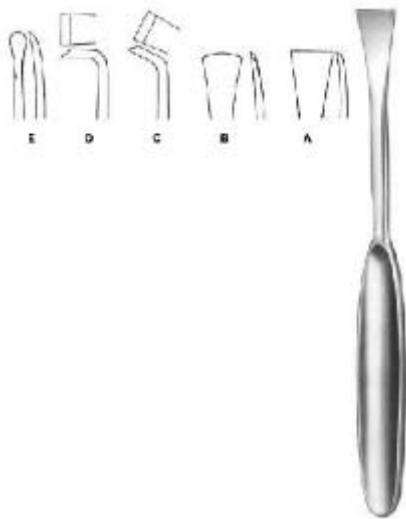

Martin-Langenbeck

UE-7-195-01

Periosteal Elevator
19 cm 16mm,



Langenbeck

UE-7-196-18

Periosteal Elevator
18.5 cm,



Langenbeck

UE-7-197-19

Periosteal Elevator
19.5 cm,



UE-7-198-05

Periosteal Elevator
16 cm 5mm, 16 cm 6mm, 16 cm 7mm,



Sedillot

UE-7-199-21

Periosteal Elevator
22 cm 15mm,



Williger

UE-7-200-13

Periosteal Elevator
12.5 cm 5mm,

Bone Surgery



Kahre-Williger
UE-7-201-04

Periosteal Elevator
4 mm, 5 mm, 7 mm,

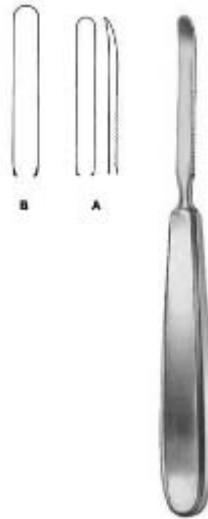

UE-7-202-06

Periosteal Elevator
17 cm 6 mm, 17 cm 8 mm,



Doyen

UE-7-203-17

Rib Raspator
17.5 cm,

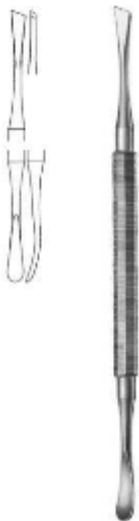

West

UE-7-204-19

Periosteal Elevator, double-ended
18.5 cm,



Ohl

UE-7-205-17

Periosteal Elevator, double-ended
17.5 cm,



Semb

UE-7-206-01

Periosteal Elevator
18.5 cm Fig. 1, 21.5 cm Fig. 2,

Bone Surgery



UE-7-207-22
Bone File
22 cm,

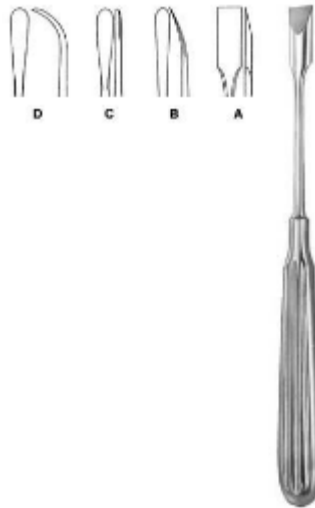

Adson
UE-7-208-17
Elevator
17 cm, 17.5 cm,

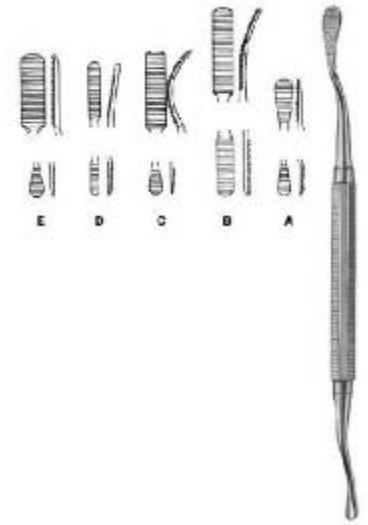

Miller-Colburn
UE-7-209-01
Bone File
18 cm Fig. 1, 18 cm Fig. 2, 18 cm Fig. 3, 18 cm Fig. 4, 18 cm Fig. 5,

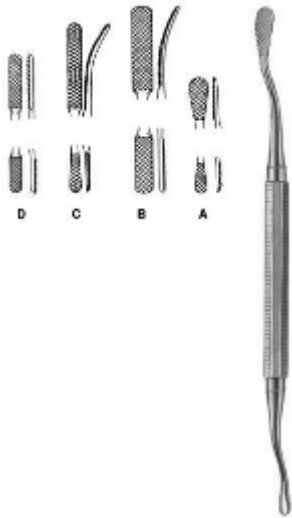

Miller-Colburn
UE-7-210-01
Bone File
18 cm Fig. 1, 18 cm Fig. 2, 18 cm Fig. 3, 18 cm Fig. 4,



Langenbeck
UE-7-211-20
Elevator
19.5 cm 8 mm, 19.5 cm 10 mm,



Martin-Langenbeck
UE-7-212-01
Elevator
17 cm 5 mm, 17 cm 7 mm, 17 cm 8 mm,



Vickers
UE-7-213-17
Elevator
17 cm,



Vickers
UE-7-214-17
Dissector
17 cm,



Williger
UE-7-215-17
Elevator
16 cm 5,5 mm,



Williger
UE-7-216-16
Elevator
16 cm 5,5 mm,



Mead
UE-7-217-17
Mallet
19 cm,



UE-7-218-18
Periosteal Elevator



Hohmann
UE-7-219-43
Bone Lever
23.5 cm,



Lempert
UE-7-220-19
Bone Rongeur
19 cm,



Luer
UE-7-221-17
Bone Rongeur
18.5 cm, 18 cm,



Zaufal-Jansen
UE-7-222-18
Bone Rongeur
18 cm,



Demel
UE-7-124-01
Wire Guide
31 cm Fig. 1, 29 cm Fig. 2, 28 cm Fig. 3,